

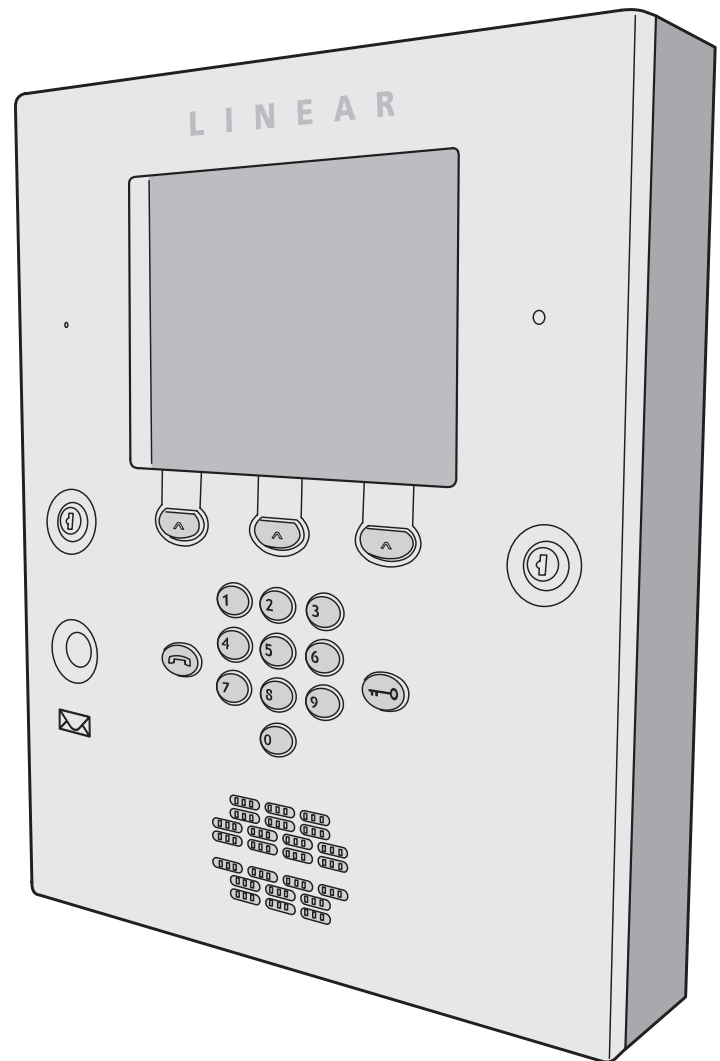

# **AE2000Plus**

## **Telephone Entry & Access Control System**



*Installation Instructions*

**Linear**<sup>®</sup>

(760) 438-7000  
USA & Canada (800) 421-1587 & (800) 392-0123  
Toll Free FAX (800) 468-1340  
[www.linearcorp.com](http://www.linearcorp.com)

## Contents

Introduction .....	2
Operation.....	2
Programming and Cardholder Maintenance.....	2
Hardware Features .....	3
Software Highlights .....	3
Feature Overview.....	3
Accessory Overview.....	4
PBUS Accessories.....	4
Wiegand Accessories .....	4
Component Locations .....	5
Wiring Diagram.....	6
Important Mounting Requirements.....	7
Entry System Mounting.....	8
Relay Output Wiring .....	10
Power, Battery, & Ground Wiring .....	11
RS-232 Port.....	11
Telephone Wiring .....	12
Optional Radio Antenna.....	12
Optional Postal Lock .....	13
Optional Color CCTV Camera .....	13
PBUS Accessories.....	14
Wiegand Accessories .....	14
Optional Network Connections.....	15
System Adjustments .....	18
System Diagnostics .....	18
Internal Controls .....	19
AE2000Plus Operation .....	20
Specifications .....	21
Dimension Drawing.....	21
Troubleshooting .....	22
Linear Limited Warranty.....	23
FCC Notice.....	23

Throughout this manual, multiple-unit networks are referenced. Depending on the programming method used, networks can contain the following model units:

NETWORK MODEL OPTIONS	
With AccessBase2000 Programming	With AXNET Programming
AM3Plus	AM3Plus
AE1000Plus	AE1000Plus
AE2000Plus	AE2000Plus
AM-3	
AE-1000	
AE-2000	

## Introduction

The Model AE2000Plus Telephone Entry & Access Control System is designed for use as a primary access control device for gated communities, parking garages, office buildings, apartments, dormitories, hotels/motels, commercial buildings and recreational facilities.

Housed in a locked, rugged stainless steel faced enclosure, the AE2000Plus features a lighted keypad with bright, easy-to-read graphics, a large backlit display with programmable welcome message, a built-in microphone, speaker, and provision for an optional color CCTV camera. The cabinet is monitored with a magnetic “tamper” switch.

The four relay output channels can be programmed to control electric door strikes, magnetic locks, door & gate operators, or barrier gates.

The system utilizes hands-free, full duplex telephone communications between visitors and residents for granting access. Complete access control event logging, access time restriction, access location restriction, and administration functions are also available to manage the installation.

The AE2000Plus is network ready. Multiple units can be interconnected on a 3-wire RS-485 network or through modems. The AE2000Plus can be used in mixed networks with its sister products, the AE1000Plus and AM3Plus.

Two Wiegand inputs are available for connection of 26, 30, or 31-bit Wiegand devices (card readers, etc.). Three sets of PBUS inputs are available for connection to Linear’s line of remote accessories.

## Operation

In a typical installation, the unit’s memory would be programmed with each resident’s name and directory code number. Arriving visitors would use the keys on the AE2000Plus to view the directory names and directory number for the desired resident. Upon selecting the directory number, the AE2000Plus will automatically dial the resident’s telephone number and establish two-way voice communication between the visitor and the resident. The resident will then have the option to grant or deny access to the visitor by pressing a digit on their telephone.

In addition to the telephone entry, the AE2000Plus can grant access using entry codes at the local or remote keypads. Also remote receivers, card readers, and interior and exterior keypads can be used with the system.

Block coded MegaCode® transmitters can be used to gain access through the AE2000Plus’s built-in or remote radio receivers. Each transmitter can be individually suspended or re-activated.

The system’s clock/calendar can control access based on specific times and dates. Automatic relay activation can be scheduled. Access can be restricted to certain times and dates. Holiday access can be scheduled.

The system’s event log records system activity for future reference.

## Programming and Cardholder Maintenance

Two programming methods can be used with the system: Linear’s AXNET or AccessBase2000. Each has its advantages, but only one must be chosen at the onset for each installation. Once a unit is programmed with one method, all programming data will be lost if a decision is made to switch to the other method.

Linear’s AXNET software is built into each unit. It allows connecting to the unit using common browser software from any PC at any location. Each unit’s database is stored in the unit’s memory.

Linear’s AccessBase2000 software installs in one dedicated PC and is designed with many extra features usually for large network installations. The database for the entire system is stored in the dedicated PC.

## Hardware Features

- ✓ **BUILT-IN RADIO RECEIVER**  
*Variable gain, high-sensitivity receiver for wireless transmitters*
- ✓ **FOUR FORM "C" (N.O. & N.C) RELAYS**  
*Each relay has 3-amp @ 24-volt rating*
- ✓ **FOUR REQUEST-TO-EXIT INPUTS**  
*Activates access device for exiting using a hardwired switch*
- ✓ **FOUR SENSING INPUTS**  
*For sensing door position to control door-ajar and alarm features, or for access inhibit timer*
- ✓ **BUILT-IN ANNUNCIATOR**  
*Chirps during keystrokes*
- ✓ **BUILT-IN MODEM**  
*No add-on modem required for telephone communications with system*
- ✓ **RS-232 PORT**  
*COM port for direct connection to a computer*
- ✓ **NETWORK SUPPORT**  
*Multiple units can be connected together to share data*
- ✓ **EXPANSION INTERFACE SUPPORT**  
*Model AM-MIO accessory adds additional input and outputs to the AE2000Plus*
- ✓ **ON-BOARD CLOCK/CALENDAR CIRCUIT**  
*Stamps the event log data as it is stored in the system's memory*
- ✓ **WIEGAND INPUTS**  
*Two Wiegand format card reader inputs for connection to external devices.*
- ✓ **LINEAR PBUS SUPPORT**  
*Three PBUS input/output ports for connection of up to 6 Linear accessories.*
- ✓ **CCTV COLOR CAMERA SUPPORT**  
*Model CCM-1 accessory camera allows color video monitoring of the keypad area*
- ✓ **POWER FAILURE MONITOR**  
*AC power input is monitored, power outages are recorded in the event log*

## Software Highlights

- ✓ **COMPUTER PROGRAMMABLE**  
*No dedicated programmer required, program with a computer and a modem*
- ✓ **LARGE ENTRY CODE CAPACITY**  
*Up to 20,000 entry codes can be used for gaining access*
- ✓ **2-8 DIGIT ENTRY CODE LENGTH**  
*Flexible code length for different applications*
- ✓ **LARGE RESIDENT DIRECTORY CAPACITY**  
*Up to 10,000 residents*
- ✓ **2-4 DIGIT DIRECTORY NUMBER LENGTH**  
*Directory number lengths can be customized for small or large installations*
- ✓ **LARGE TRANSMITTER CAPACITY**  
*Up to 45,600 block coded and 20,000 individually enrolled Linear transmitters can be used for gaining access*
- ✓ **TRANSMITTER FACILITY CODE SUPPORT**  
*Identifies wireless transmitters by installation*
- ✓ **LARGE CARD CAPACITY**  
*Up to 45,600 block coded and 20,000 individually enrolled cards can be used for gaining access*
- ✓ **FOUR INDEPENDENT RELAY CHANNELS**  
*Each output's action is programmable*
- ✓ **PROGRAMMABLE TIME SCHEDULED RELAY ACTIVATION**  
*Activation for up to four time periods for each of the 31 system time zones*
- ✓ **PROGRAMMABLE TIME ZONE ACCESS VALIDATION**  
*Validation during four time periods for each of the 31 system time zones*
- ✓ **PROGRAMMABLE VALIDATION DAYS**  
*Select days of the week access is allowed*
- ✓ **PROGRAMMABLE HOLIDAY DAYS**  
*Select up to 24 expiring & 24 non-expiring holidays for access restriction*
- ✓ **OBSTACLE TRANSMITTER SUPPORT**  
*Compatible with Linear's Model MGT transmitter*
- ✓ **EVENT LOG**  
*Stores up to 20,000 system events in memory for record keeping*
- ✓ **DELETED CARDHOLDER DATABASE**  
*System logs deleted cardholders for future identification*
- ✓ **TIMED OR TRUE ANTI-PASSBACK**  
*Options to temporarily disable a cardholder's credentials after access for a preset time or depending on the cardholder's access direction*

## Feature Overview

### Relay Outputs

Four 3-amp dry contact relay outputs are provided to activate access devices, such as door strikes, magnetic locks, automatic doors, barrier gates, and automatic sliding gates. The relay outputs can also be used as specialty outputs for alarm contact shunting, operator obstacle triggering, and alarm activation. Each of the relays can also be manually activated from buttons on the AE2000Plus circuit board. LED indicators display the status of each relay.

### Request-to-Exit Inputs

Each relay channel has a request-to-exit input. These inputs are supplied for hardwire activation of the access devices. Typically a request-to-exit input is wired to a pushbutton inside of the access controlled area. When a person desires to exit, pressing the pushbutton will activate the output relay channel and trigger the access device. A loop detector for automatic gate operation can be connected to a request-to-exit input.

### Sensing Inputs

The sensing inputs connect to door switches that monitor whether the controlled door is open or closed. The sensing inputs may alternately be programmed as "access inhibit" inputs for use with an external timer or service switch.

### Built-in Modem

A modular connector is provided for telephone line connection to the unit's built-in 33.6K baud modem. The system can be accessed remotely for programming and control over the standard telephone system using a personal computer with a modem. For system backup, a computer connected through the modem can store and retrieve the AE2000Plus's memory data.

### RS-232 Communications Port

A modular connector is provided for the bi-directional 38.4K baud RS-232 port. The AE2000Plus's RS-232 port connects to a personal computer's COM port. System programming can be performed locally with a computer connected to the RS-232 port.

### Local Keypad

The local keypad is the system's primary keypad. The local keypad activates Relay Channel "A", but can be programmed for any of the relays.

### Postal Lock

The AE2000Plus cabinet has provisions for installing a U.S.P.S. postal lock for keyed mail carrier access. The postal lock will activate Relay Channel "A", but can be programmed for any of the relays.

### Obstacle Detection

Linear's Model MGT safety edge transmitter is compatible with the AE2000Plus. The MGT detects and transmits obstacle events to the AE2000Plus.

### Programming Memory

The AE2000Plus flash memory retains all entry codes, transmitter information, card access, and programming, even without power.

### Battery Backup

The system supports a 12-volt battery backup or uninterruptable power supply for operation during power outage. The system does not charge the backup battery, an external battery charger is required to maintain the battery.

### Network Support

Multiple AE1000Plus, AE2000Plus, & AM3Plus units can be networked together via three-wire RS-485 cables or through modems allowing information sharing between the units. A common event log is retained for all of the networked units.

### Linear PBUS Ports

Three 6-wire Linear PBUS input/output ports are available to connect to several accessories (keypads, proximity readers, remote receivers). A typical application for a remote keypad or reader would be to control additional doors or gates.

## Accessory Overview

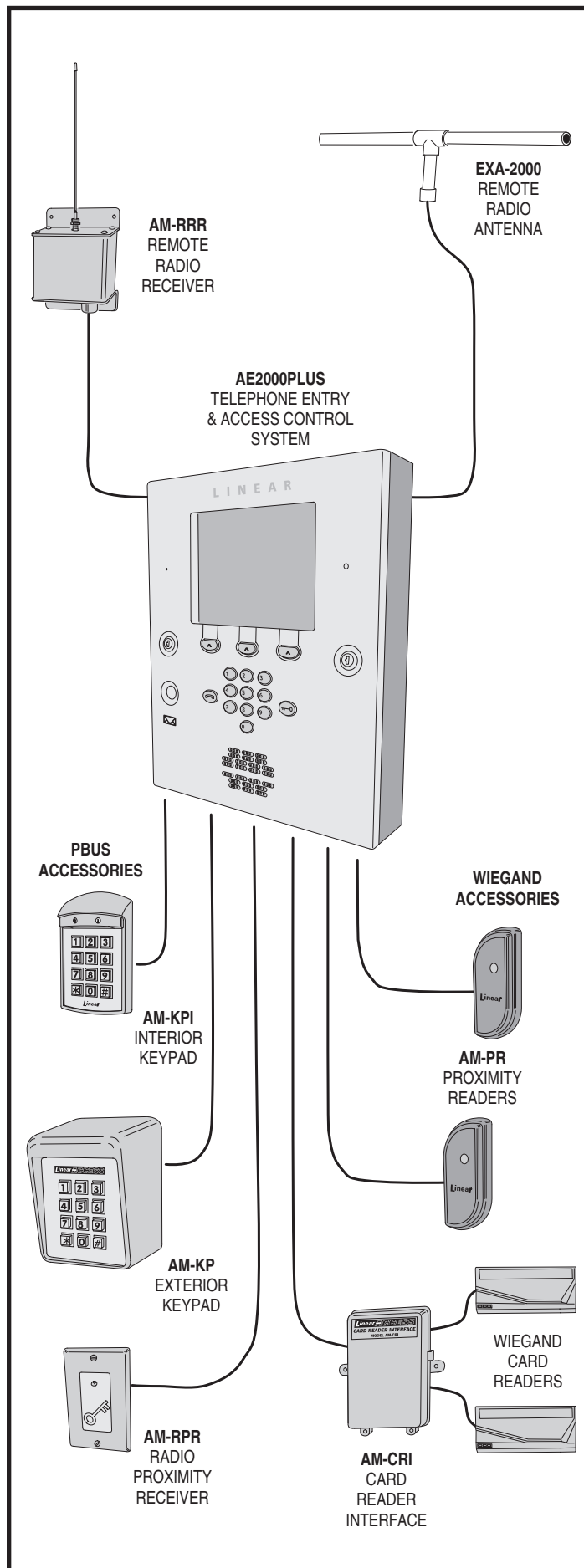

## PBUS Accessories

Several compatible accessories are available to connect to the three 6-wire communications "PBUS" inputs. Up to six PBUS accessories can be used with each AE2000Plus unit.

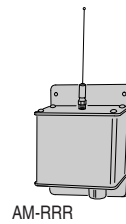

### AM-RRR Remote Radio Receiver

For wireless transmitters, connect the Model AM-RRR high-gain superheterodyne UHF receiver. The receiver is housed in a weather-resistant enclosure and can be mounted indoors or outdoors. Gaskets and a weather-tight wiring strain relief seal the unit from the elements.

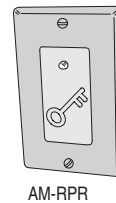

### AM-RPR Radio Proximity Receiver

The Model AM-RPR functions as a remote device that supplies localized radio reception for the AE2000Plus. In a typical installation, the AM-RPR would be mounted in a plastic single-gang electrical box next to the controlled opening. When the user requires access, their transmitter must be activated within three inches of the AM-RPR faceplate.



### AM-KP Exterior Keypad

The Model AM-KP is housed in a rugged cast aluminum enclosure designed for exterior installations. The die-cast keys have bright, easy-to-read yellow graphics. The keypad can be mounted to a pedestal or directly to a wall. A keylock secures the keypad to the mounting backplate.



### AM-KPI Interior Keypad

The Model AM-KPI keypad is housed in a rugged, plastic enclosure designed to be mounted indoors in a standard single-gang electrical box. Tamper resistant screws secure the keypad to its mounting plate. The die-cast keys have bright, easy-to-read yellow graphics and is illuminated with white LEDs. The keypad is supplied with a satin-chrome bezel and three interchangeable colored bezels (white, ivory, & bronze) to customize the keypad appearance for the installation.

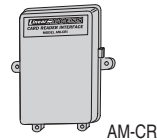

### AM-CRI Card Reader Interface

The Model AM-CRI expands the standard two AE2000Plus Wiegand inputs by supporting one or two additional 26-bit Wiegand input devices per AM-CRI interface used.

## Wiegand Accessories

The two WIEGAND format inputs connect WIEGAND devices to the AE2000Plus. Linear offers a Wiegand format proximity reader. Most other manufacturer's 26, 30 & 31-bit WIEGAND output devices can also be used with the AE2000Plus.

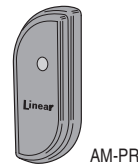

### AM-PR Proximity Reader

The Model AM-PR is a radio-based reader that works with either proximity tags (Model AM-PT) or proximity cards (Model AM-PC), both of which are slotted to attach to key rings. Upon reading a user's tag or card, the reader sends the entry data via a Wiegand output to the AE2000Plus. An integral LED confirms to the user that access is granted.

# Component Locations

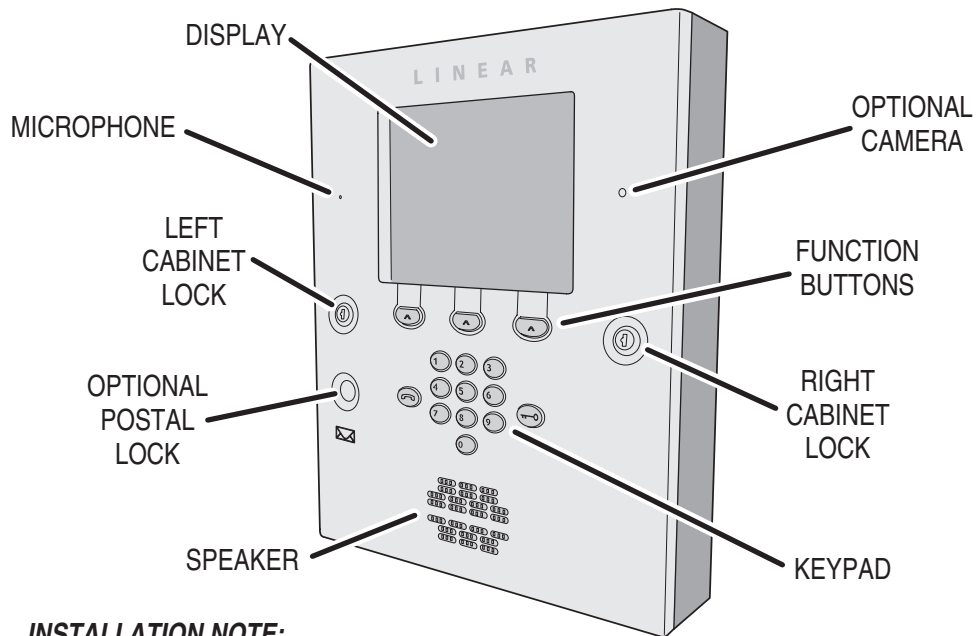

**INSTALLATION NOTE:**

**FOR EASY WIRING, THE UNIT'S TERMINAL BLOCKS CAN BE UN-PLUGGED FROM THE CIRCUIT BOARD**

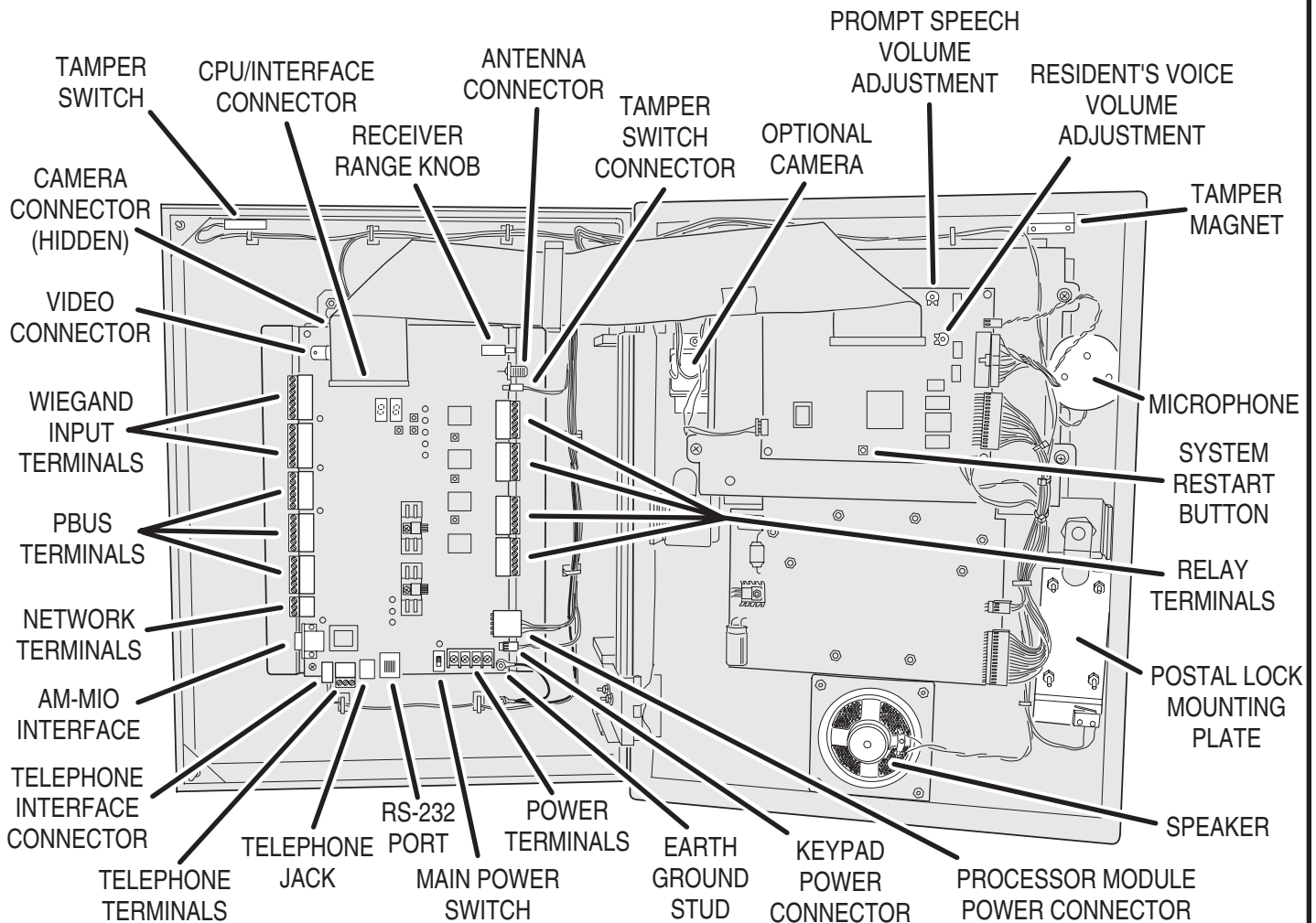

# Wiring Diagram

**THIS WIRING EXAMPLE SHOWS:**  
**DOOR ACCESS WITH A DOOR STRIKE ON RELAY CHANNEL "A"**  
**DOOR ACCESS WITH A MAGNETIC LOCK ON RELAY CHANNEL "B"**  
**GATE ACCESS WITH A GATE OPERATOR ON RELAY CHANNEL "C"**  
**(YOUR INSTALLATION MAY VARY)**

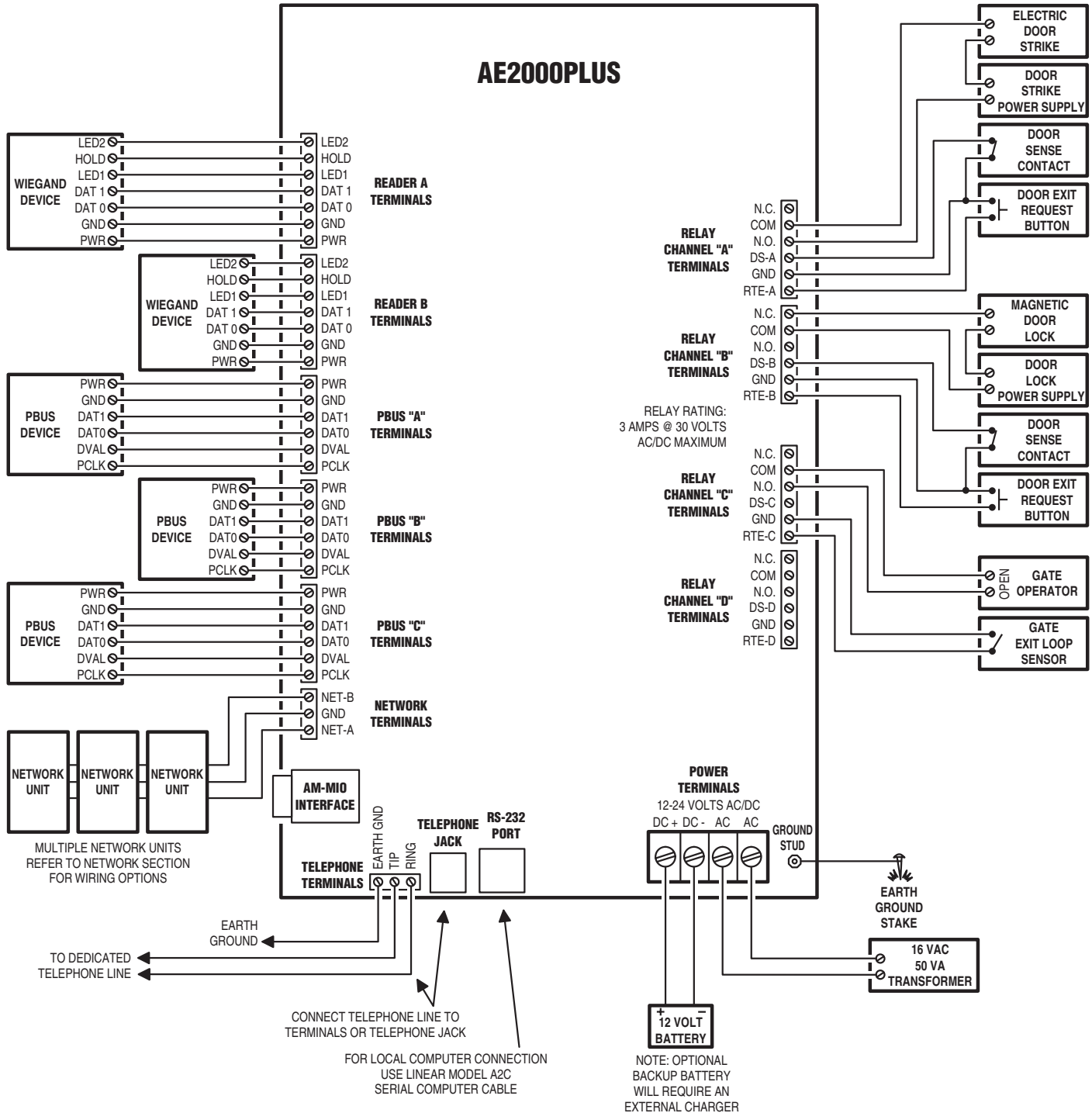

# Important Mounting Requirements

The AE2000Plus Telephone Entry System can be installed for public or private use. The mounting requirements will vary depending on the installation. Review the following information before beginning the installation.

## Mounting Environment

Consider the environmental factors at the desired mounting location. The AE2000Plus is designed for direct outdoor installations, however, it is preferable to protect the unit from extreme exposure to sun, driving rain, or snow whenever possible. Mounting the unit in a kiosk can provide extra environmental protection.



## Follow Building Codes

Check all local building codes and ordinances prior to installing the system. Proper installation of the AE2000Plus conforming to the local building codes for access control equipment is a regulatory requirement. The AE2000Plus installation is an extremely important and integral part of the overall access control system.



## Mounting Location

If the AE2000Plus is used to control a door or pedestrian gate, locate the unit as near as practical to the entry point. If the unit is mounted on or in a wall adjacent to the entry point, be sure the wall is sturdy. The repeated shock and vibration from a slamming access door or spring-loaded pedestrian gate must be isolated from the AE2000Plus. **NEVER MOUNT THE UNIT DIRECTLY TO A MOVING DOOR OR GATE!**

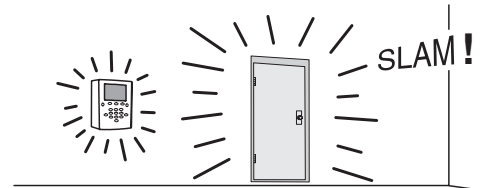

## Gate Installations

If the AE2000Plus is used to control a gate operator connected to a vehicular gate, the unit **MUST** be mounted **AT LEAST 10 feet** away from the gate (open and closed) and gate operator. **AT NO TIME SHOULD A PERSON BE ABLE TO TOUCH THE GATE OR GATE OPERATOR AND THE AE2000Plus AT THE SAME TIME.**

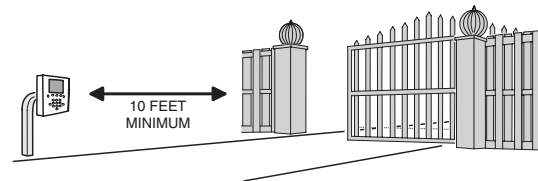

## Vehicle Traffic

Do not mount the AE2000Plus where it extends into any traffic lane. Locate the gooseneck pedestal or entry kiosk so all parts of the AE2000Plus are outside the traffic lane. Locate the AE2000Plus clear of any turn-around lanes vehicles use when access is denied.

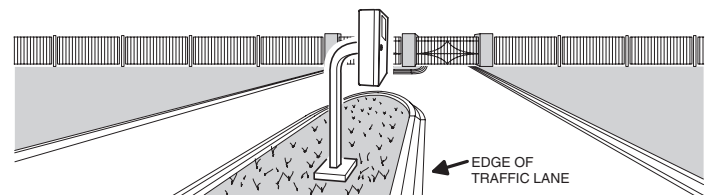

## Americans with Disability Act (A.D.A.) Requirements

THE FOLLOWING WHEELCHAIR ACCESS REQUIREMENTS ARE FOR PUBLIC DOOR CONTROL INSTALLATIONS ONLY.

1. If the clear floor space allows only forward approach to the system, the maximum high forward reach allowed is 48" above grade to the top of the keypad.
2. If the high forward reach to the system is over an obstruction of greater than 20" but less than 25", the maximum high forward reach allowed is 44" above grade to the top of the keypad.
3. If the clear floor space allows parallel approach by a person in a wheelchair, the maximum high side reach shall be 54" above grade to the top of the keypad.
4. If the high side reach is over an obstruction of 24" or less, the maximum high side reach allowed is 46" above grade to the top of the keypad.



# Entry System Mounting

The AE2000Plus cabinet is designed to be mounted three ways:

- The unit can be mounted directly to a wall or flat surface.
- The unit can be mounted recessed into the wall.
- The unit can be mounted on a standard gooseneck pedestal.

Choose a well lit location near the controlled opening. Wiring access for power, telephone, earth ground, control output must be available to the mounting location. If the optional remote accessories are used, wiring access for these cables must also be available to the mounting location.

## Opening and Closing the Cabinet

The AE2000Plus's cabinet hinges are spring loaded to help weather seal the cabinet. To open the cabinet, **press the cabinet door firmly** around each lock while turning each key counterclockwise. To close the cabinet, **press the cabinet door firmly** around each lock while turning each key clockwise.

## Mounting Preparation

Before mounting the system, the main circuit board mounting plate must be removed to provide access for the wiring hole and mounting fasteners.

◆ **CAUTION!:** Touch a grounded object before proceeding to discharge static electricity from your body.

1. Carefully remove the five main circuit board wiring connectors:
  - The CPU/interface ribbon cable connector.
  - The processor module power connector.
  - The telephone interface connector.
  - The tamper switch connector.
  - The keypad power connector.
2. Remove the nut from the Earth Ground stud and remove the green ground wire lug from the stud.
3. Remove the two bottom circuit board mounting plate nuts.
4. Loosen the two top circuit board mounting plate nuts.
5. Carefully lift up on the mounting plate, removing the circuit board mounting plate. Set it aside in a safe place.

Reverse these steps to replace the circuit board mounting plate after the cabinet mounting is complete.

## Surface Mounting

The cabinet can be mounted on a wall or any suitable flat surface. The four 3/8" mounting holes or the four self-drill locations can be used to attach the cabinet to the surface.

1. For wall mounting, hold the cabinet at the approximate mounting location where the display will be about eye level or slightly above.
  - 2A. If using the 3/8" mounting holes, mark the four mounting hole centers. Drill as required. Use the appropriate fasteners for the mounting surface to secure the cabinet.
  - 2B. If using the self-drill mounting holes, choose the correct size bit for the fasteners and drill the cabinet as required. Use the appropriate fasteners for the mounting surface to secure the cabinet.
3. After routing the wiring into the cabinet, replace the circuit board mounting plate and plug in the wiring connectors. Be sure to replace the green ground wire.

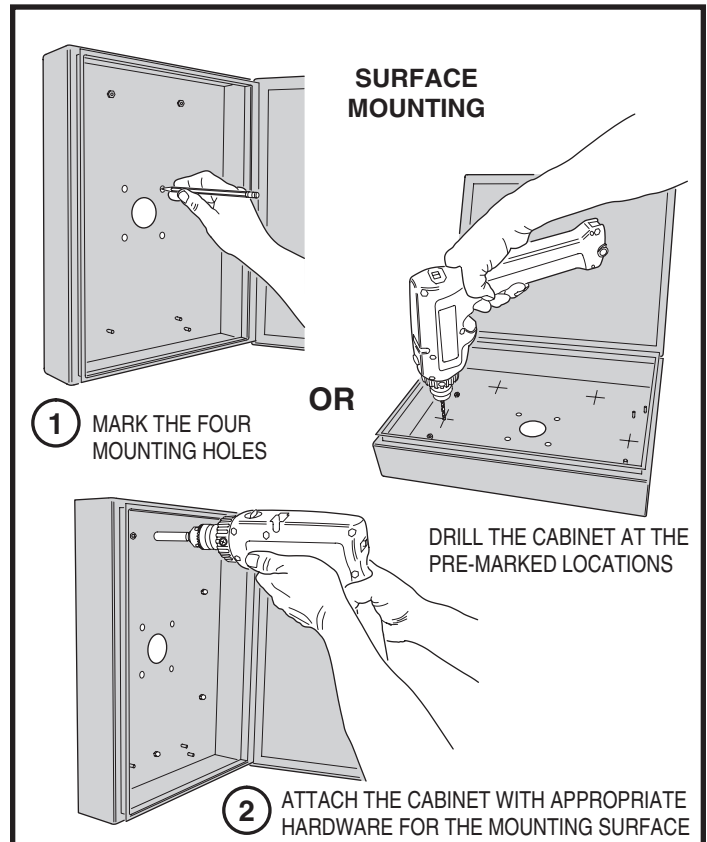
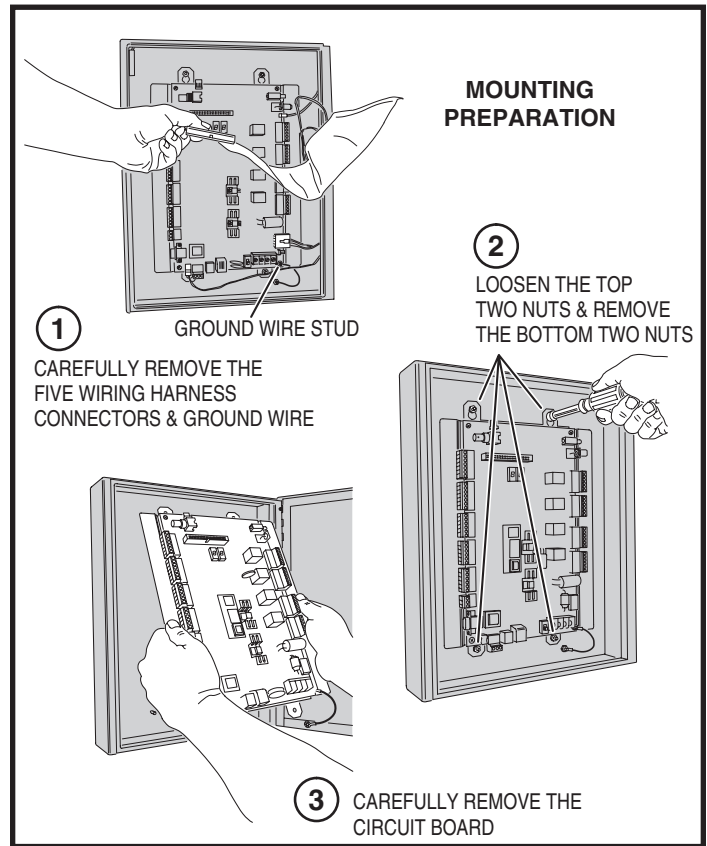



# Entry System Mounting (Continued)

## Recessed Mounting

The cabinet can be mounted recessed using the accessory trim-ring (P/N ACP00914). The trim-ring mounts in the wall and the cabinet attaches to the trim-ring.

1. Identify the location of any studs in the wall.
2. Cut a 15-1/2" wide by 19" high rectangular hole between studs at the mounting location.
3. Install any additional mounting material required to provide surfaces inside the wall 15-1/2" apart for attaching the trim-ring.
4. Place the trim-ring in the wall hole. Check for level, then attach the trim-ring with up to six screws into the side tabs.
5. Drill the cabinet's six self-drill mounting holes the appropriate size for the hardware.
6. Attach the cabinet to the trim-ring using self-tapping screws.
7. After routing the wiring into the cabinet, replace the circuit board mounting plate and plug in the wiring connectors. Be sure to replace the green ground wire.

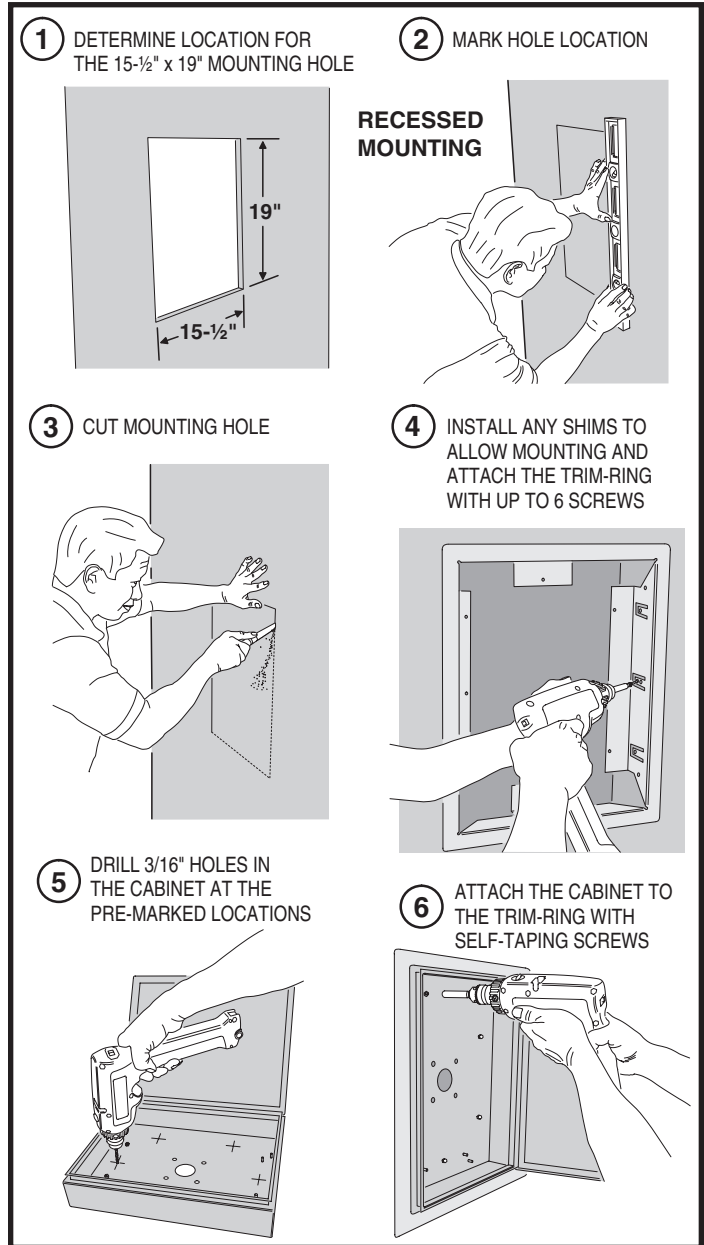

## Pedestal Mounting

The cabinet can be mounted on a gooseneck pedestal. Linear manufacturers two pedestals: Model GNC-1 is for surface mounting with concrete fasteners, Model GNB-1 is for burial mounting. When mounting to a pedestal, use the cabinet reinforcing plate to stiffen the cabinet.

1. Install the pedestal at the desired location.
2. Place the reinforcing plate *inside* the cabinet.
3. Use security hardware to attach the cabinet and reinforcing plate to the pedestal.
4. After routing the wiring into the cabinet, replace the circuit board mounting plate and plug in the wiring connectors. Be sure to replace the green ground wire

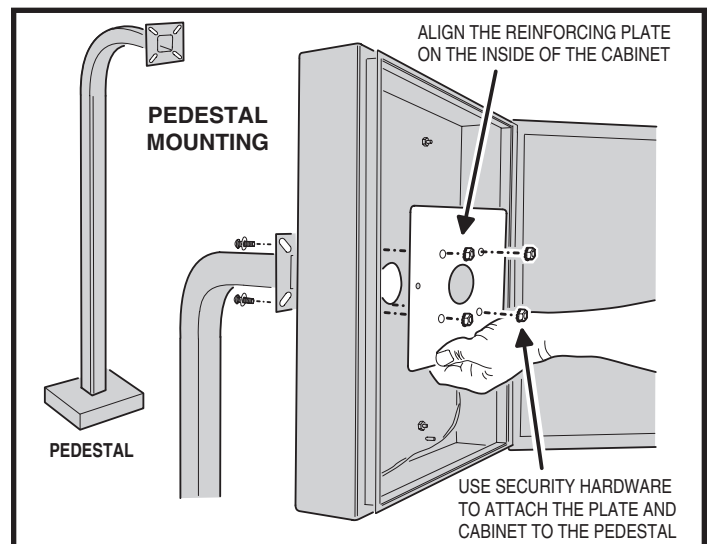

# Relay Output Wiring

Any of the four relay outputs channels (A-D) can be used to control access devices on doors or gates.

## Door or Pedestrian Gate Control

1. Install a low voltage electric door strike or magnetic lock as a locking device for the door or pedestrian gate.
2. Install the power supply or transformer for the locking device. **DO NOT POWER THE AE2000Plus FROM THIS POWER SUPPLY.**
3. Connect one wire from the power supply to one wire from the locking device.
4. Route two wires between the locking device and the AE2000Plus. Connect one wire to the remaining wire of the locking device. Connect the other wire to the remaining wire of the power supply.
- 5A. For a door strike, connect the wires to the AE2000Plus relay **COM** & **N.O.** terminals.
- 5B. For a magnetic lock, connect the wires to the AE2000Plus relay **COM** & **N.C.** terminals.

## Gate Control

1. Route two wires between the gate and the AE2000Plus.
  2. Connect the gate operator's **OPEN** terminals to the AE2000Plus relay **COM** & **N.O.** terminals.
- ◆ **NOTE:** For operator wiring specifics, refer to the gate operator's wiring diagram.

## Request-to-Exit Inputs

Each of the four relay outputs has a request-to-exit input terminal. Grounding this terminal will activate the associated relay. Exit request inputs are typically used with push bars, loop sensors, or pushbuttons.

1. Install the pushbutton or device to signal an exit request.
2. Route two wires from the device to the AE2000Plus.
3. Connect the device's normally open output to the wires.
4. To activate a relay channel, connect the wires to the associated relay request-to-exit terminal (**RTE-A**, **RTE-B**, **RTE-C**, or **RTE-D**) and **GND** terminals.

## Sensing Inputs

The sensing inputs can connect to a door switch that monitors whether the controlled door is open or closed.

1. To use the door sense feature to detect forced entry or door ajar conditions, install a normally closed door switch on the door or pedestrian gate and route two wires from the switch to the AE2000Plus.
2. Connect the sensing device wires to the associated relay sensing terminal (**DS-A**, **DS-B**, **DS-C**, or **DS-D**) and **GND** terminals.

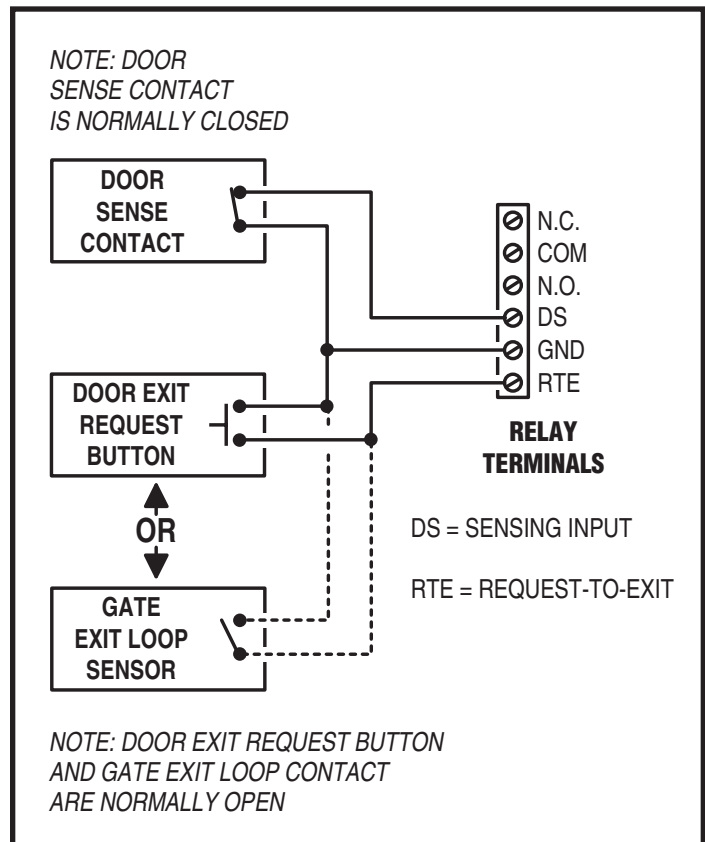
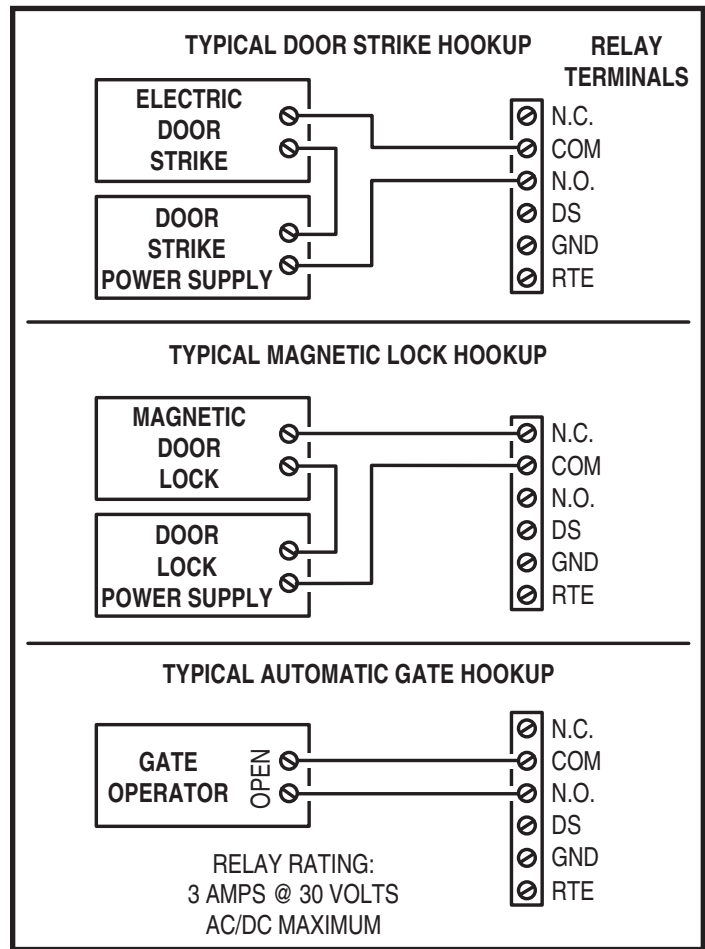

# Power, Battery, & Ground Wiring

## Power Wiring

◆ **NOTE: DO NOT APPLY POWER UNTIL THE INSTALLATION IS COMPLETE. TURN MASTER POWER SWITCH OFF BEFORE WIRING.**

1. Route two wires between the AE2000Plus and the power transformer.
  - For power wire runs up to 75 feet, use 18 AWG, THHN 600-volt insulated wire.
  - For power wire runs up to 150 feet, use 16 AWG, THHN 600-volt insulated wire.
2. Connect the wires to the transformer. Connect the other end of the wires to the AE2000Plus **AC1** & **AC2** terminals.

## Backup Battery / Uninterruptable Power Supply

Use of battery backup is optional. It will allow the AE2000Plus to operate for short periods of time without AC power. The door or gate access device must use some type of battery backup of its own for the entire system to be functional.

A backup battery will not fit into the AE2000Plus case. Protect the backup battery inside a rain-tight NEMA enclosure suitable for the installation.

◆ **NOTE: A backup battery is not required to maintain the AE2000Plus clock/calendar and programming memory during power outages.**

1. Route two wires between the AE2000Plus and the backup battery.
2. Connect the Battery positive to the AE2000Plus **DC+** terminal and the negative to the **DC-** terminal.

◆ **NOTE: The AE2000Plus does not supply battery charging current. An external battery charger will be required to maintain the battery.**

## Earth Ground

For the best ground, use size 12 gauge solid wire or larger to connect to an 8-foot copper ground rod. Locate the ground rod next to the Power and Telephone company rods and bond the rods together with a new clamp. Do not disturb the clamps installed by the Power or Telephone Company. Alternately, connect to a metallic cold water pipe for the earth ground.

1. Connect the wire from the earth ground to the AE2000Plus **EARTH GROUND STUD**.

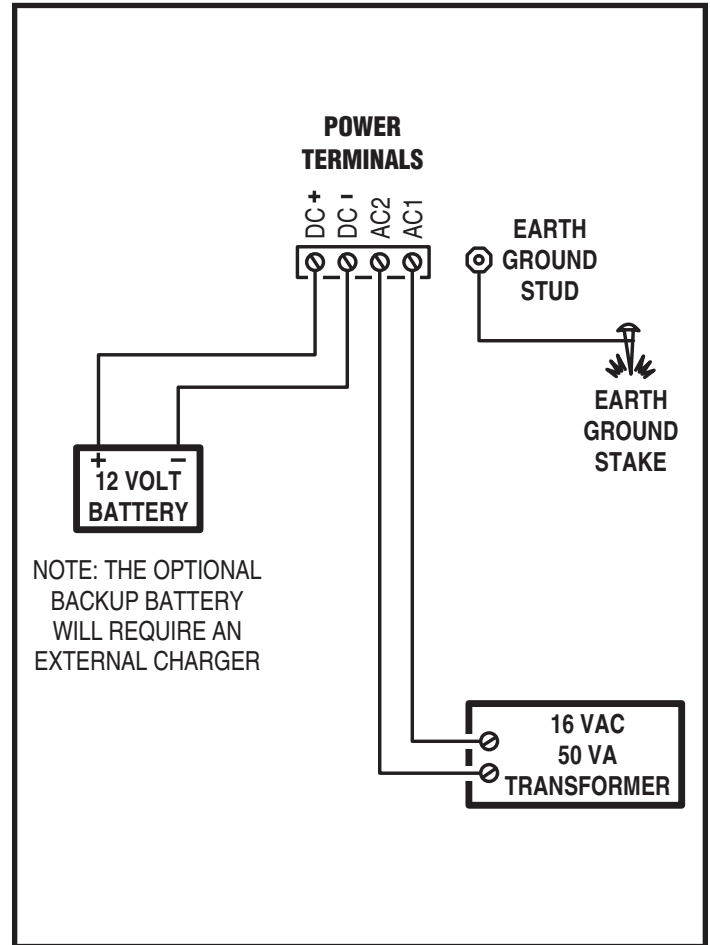

## RS-232 Port

A modular connector is provided for the bi-directional 38.4K baud RS-232 port. The AE2000Plus's RS-232 port connects to a personal computer's COM port. System programming can be performed locally with a computer connected to the RS-232 port using the AccessBase 2000 software.

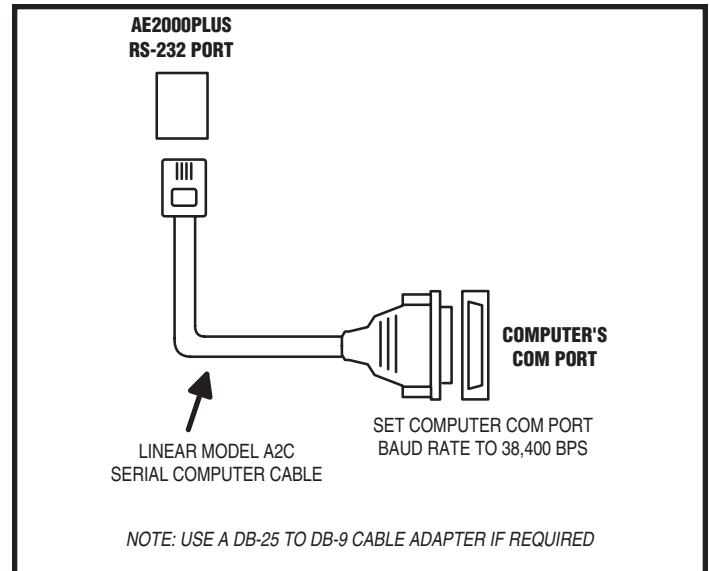

# Telephone Wiring

For telephone entry and programming, the AE2000Plus connects to a standard telephone line.

## Important Telephone Wiring Tips

- **DO NOT ROUTE TELEPHONE AND AC WIRING INSIDE THE SAME CONDUIT.** Route all telephone wires inside a dedicated conduit that is at least six inches away from any AC line wiring.
- All telephone wiring must be made on the “building” side of the telephone company’s demarcation device (the terminal block where the telephone line connects to the building).
- If any security system or personal alert system at the installation is connected to the telephone line, be sure that it is connected to the line ahead of the AE2000Plus using a RJ-31X or RJ-38X interface.
- Use only high-quality telephone wire. All telephone wire should be twisted-pair with a minimum size of 24 AWG.

## Typical Telephone Wiring

- 1A. If using the AE2000Plus modular connector for the telephone connection, connect a double-ended modular cable between the AE2000Plus **PHONE** jack and the modular telephone jack wired to the installation’s telephone line.
- 1B. If using the AE2000Plus terminal block for the telephone connection, before connecting the telephone line, check the polarity of the wires with a DC voltmeter. Connect the negative wire (usually green) to the **RING** terminal. Connect the positive wire (usually red) to the **TIP** terminal.

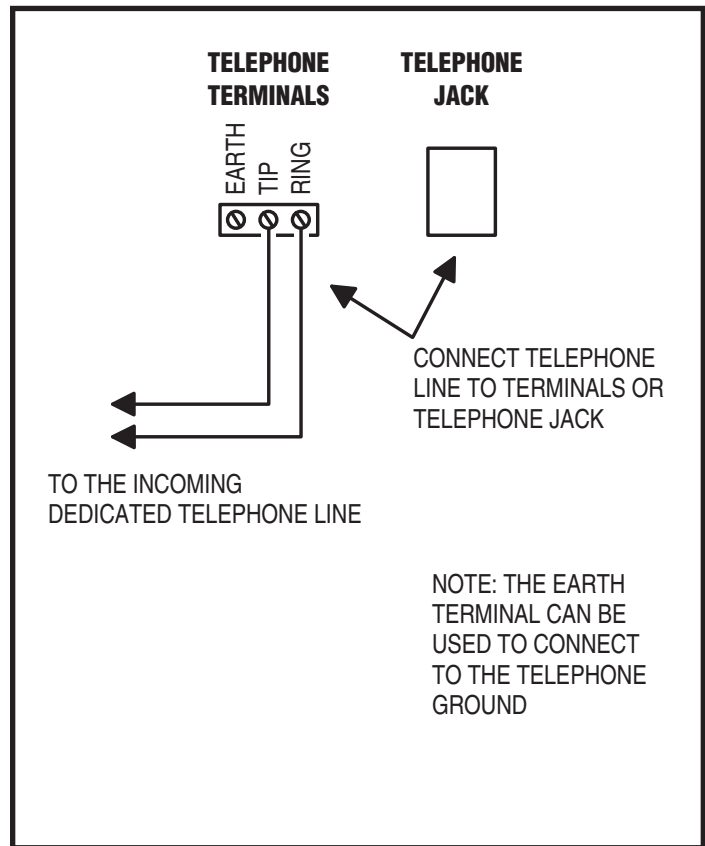

# Optional Radio Antenna

If wireless transmitters are going to be used in the system a remote antenna must be installed to provide reception for the AE2000Plus.

A basic antenna kit is supplied with the AE2000Plus. The kit contains a whip antenna, connector, and a 36” length of coax cable. The antenna connector should be mounted on a metal surface using a 3/8” hole.

Two other models of antennas are compatible with the AE2000Plus. The Model EXA-1000 is a non-directional antenna. The Model EXA-2000 is a directional antenna used in installations where transmitted signals are desired to be received only in a particular direction.

◆ **NOTE:** Up to 50 feet of type RG-59 coax can be used to connect the antenna to the AE2000Plus. Keep the coax as short as possible.

1. Install the antenna. (See installation instructions if using the EXA-1000 or EXA-2000.)
2. Connect the antenna coax cable to the antenna and route the cable to the AE2000Plus.
3. Connect the cable to the AE2000Plus **ANTENNA** connector.

## Receiver Range Control

The AE2000Plus has a **RECEIVER RANGE** adjustment knob. In some installations, it may be necessary to reduce the effective radio range of the receiver to limit the distance that transmitters can be used. Reducing the radio’s sensitivity may also help in installations where unwanted interference is overpowering signals from transmitters.

1. After the installation and system programming is complete, adjust the **RECEIVER RANGE** knob to suit the installation. Test transmitters from typical locations that they will be used. Set the radio range so the receiver can activate from transmitters from about 25% more distance than required.

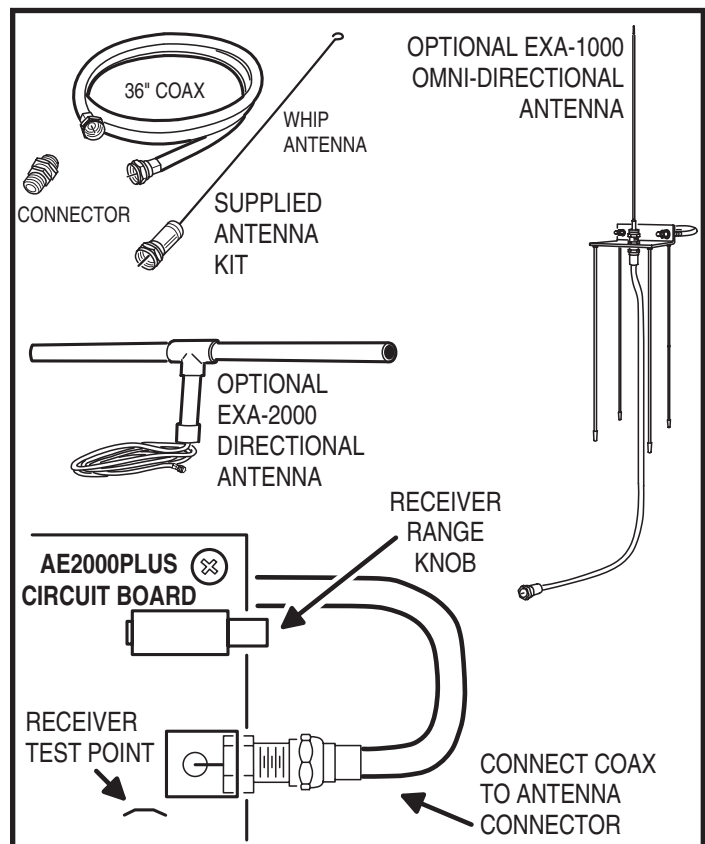

# Optional Postal Lock

A postal lock can be installed in the AE2000Plus Entry System to provide keyed access for the postal service. The AE2000Plus case is designed to accept a U.S. Postal Service postal lock. When the postal lock is engaged, the programmed output relay will activate.

## Postal Lock Installation

1. After opening the cabinet, re-lock the left cabinet lock to provide clearance to remove the postal lock switch plate.
2. Remove the four locknuts that retain the postal lock switch plate (below the left cabinet lock on the AE2000Plus faceplate).
3. Remove the switch plate from the four studs.
4. Install the postal lock assembly onto the four studs. The postal lock's moving plunger should point down (see figure).
5. Replace the postal lock switch plate with the microswitch oriented toward the front of the cabinet where it will be pressed by the postal lock's moving plunger (see figure).
6. Secure the postal lock and switch plate with the four locknuts.
- ◆ **NOTE:** Be sure the postal lock's plunger actuates the microswitch. Adjust the switch plate and the postal lock then test the action until the microswitch fully actuates.
7. Tighten the four locknuts after the adjustment and testing is complete.
8. When programming the system, set the postal lock option to activate the desired relay output.

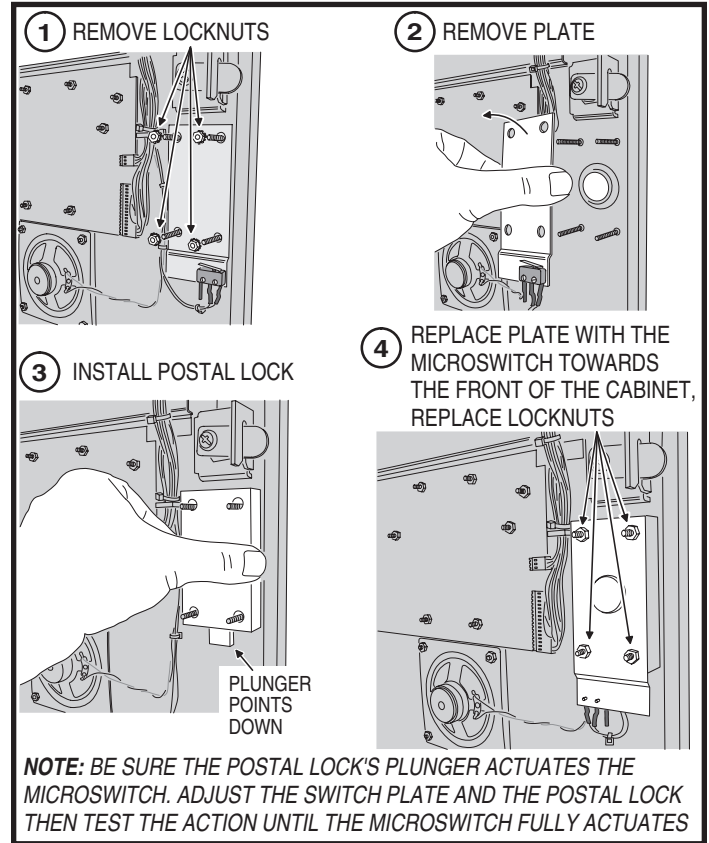

# Optional Color CCTV Camera

Linear's Model CCM-1 (P/N ACP00904) CCTV camera can be installed inside the AE2000Plus Entry System. The camera provides a video signal for viewing the area in front of the entry system.

The **CAMERA** connector is used to connect the camera to the AE2000Plus. The 4-conductor cable routes power to, and video from the camera.

The **VIDEO** jack is the camera output for connection to a video cable with a Type "BNC" connector. Up to 400 feet of 75-ohm RG-59 video cable can be used. Longer cable runs may require the use of a video amplifier.

## Camera Installation

1. Remove the two plate locknuts from the camera mounting studs above the right keylock on the AE2000Plus faceplate.
2. Remove the cover plate.
3. Remove the protective backing from the plastic window included with the camera and install the plastic window onto the studs with the adhesive side against the door.
4. Remove the lens cap from the camera.
5. Mount the camera assembly on the two studs, with the alignment hole in the camera bracket towards the top. Secure the camera with the two locknuts.
6. Connect the camera's cable to the AE2000Plus **CAMERA** connector.
7. Connect the video cable to the AE2000Plus **VIDEO** connector.
8. Connect the other end of the video cable to the viewing monitor or the video distribution system.

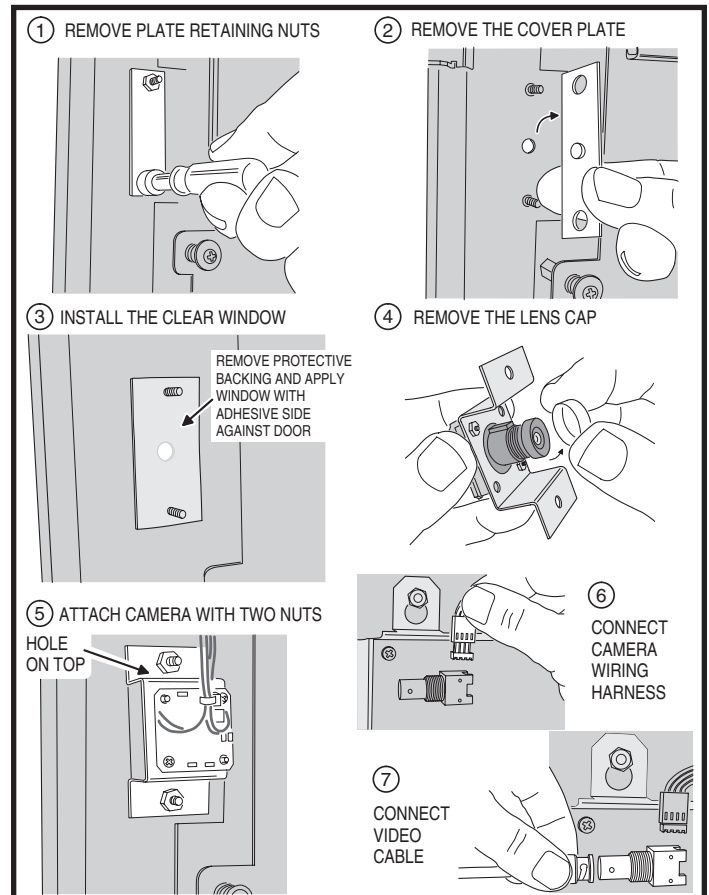

# PBUS Accessories

Up to six accessories (keypads, proximity readers, remote receivers) can be connected to the three PBUS input/output ports. A typical application for a remote keypad would be to control a second door or gate.

Linear's PBUS devices compatible with the AE2000Plus are:

- AM-RRR Remote Radio Receiver
- AM-RGR Remote Radio Receiver
- AM-RPR Radio Proximity Receiver
- AM-KP Exterior Keypad
- AM-KPI Interior Keypad
- AM-CRI Card Reader Interface

Conventional cable or commonly available Cat-5e Ethernet cable can be used to connect PBUS remote devices to the AE2000Plus. When using Cat-5e cable, note that the PWR and GND connections use two wires each to enhance the current carrying capacity for powering the remote device.

Cable choices:

- Cat-5e Ethernet cable for wire runs up to 500'.
  - 24 AWG Belden Type 9931 or equivalent for wire runs up to 300'.
  - 20 AWG Weico Type 9405 or equivalent for wire runs up to 600'.
1. Mount and install the accessory as described in its instructions.
  2. Route cable from the AE2000Plus to the accessory.
  3. Set the **DEVICE ADDRESS** rotary switch in the accessory to a unique address number. When programming the system, the device address number will identify each PBUS accessory to the AE2000Plus.
  4. Connect the cable to the accessory and the AE2000Plus (see PBUS wiring diagram).

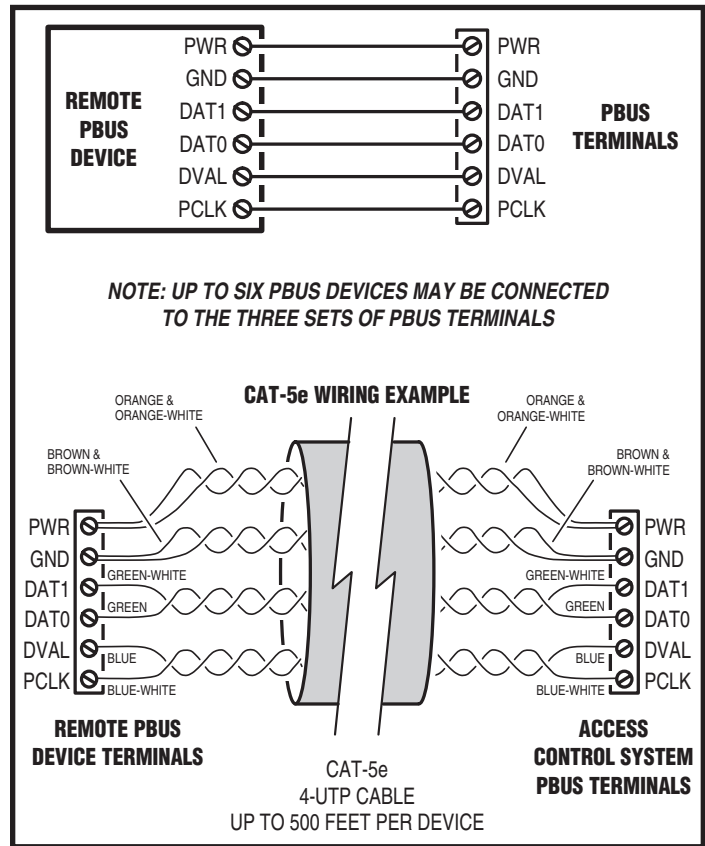

# Wiegand Accessories

The two AE2000Plus Wiegand inputs (WIEGAND A & B) can connect to a large variety of 26, 30, and 31-bit Wiegand output accessories. The Wiegand format is a common standard for access control equipment. A typical application would be to add swipe card or proximity readers to the system.

◆ **NOTE:** Depending on the Wiegand accessory used, the LED1, LED2, and HOLD connections may not be required.

- LED1 output is switched to ground during non-access time.
  - LED2 output is switched to ground for one second during access time.
1. Mount and install the Wiegand accessory as described in its installation instructions.
  2. Route a cable from the AE2000Plus to the accessory.
    - For wire runs up to 300 feet use 24 AWG Belden Type 9931 or equivalent.
    - For wire runs up to 500 feet use 20 AWG Weico Type 9405 or equivalent.
  3. Connect the cable to the accessory and the AE2000Plus as shown in the figure.

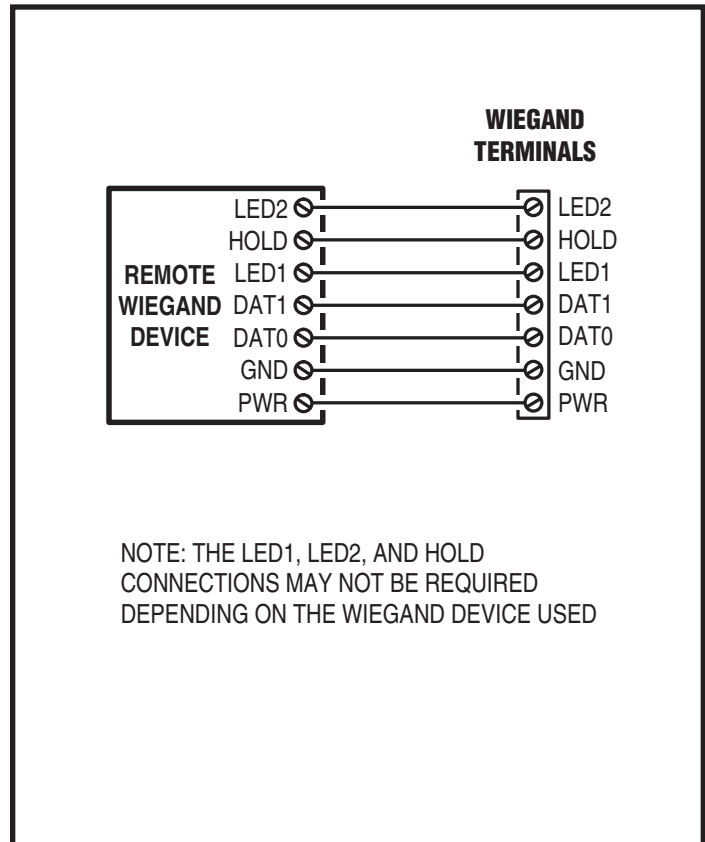

# Optional Network Connections

Linear's AE1000Plus, AE2000Plus, & AM3Plus Access Control Systems can be connected together in a network. A network will allow sharing programming and user information between the systems. Program each unit to a different network Node Address (see Page 19).

◆ **IMPORTANT COMPATIBILITY NOTE:** *Linear's previous access control Models AE-1000, AE-2000, & AM3 can be used in networks with the Models AE1000Plus, AE2000Plus, & AM3Plus only using AccessBase2000 software. The built-in AXNET Browser Interface included in the "Plus" models is only compatible with the Models AM3Plus, AE1000Plus, and AE2000Plus.*

## Network Configurations for AXNET Programming

If the system is going to be programmed using Linear's AXNET Browser Interface, units can communicate with each other on the network through modems or RS-485 cable connections.

Refer to the figure below for details of the 11 supported AXNET network hardware configurations and associated Network Configuration Numbers. After choosing a network layout that best suits the installation, note the Network Configuration Number. This number is required to be entered during setup of the AXNET Browser Interface in the Global Settings for Networking area.

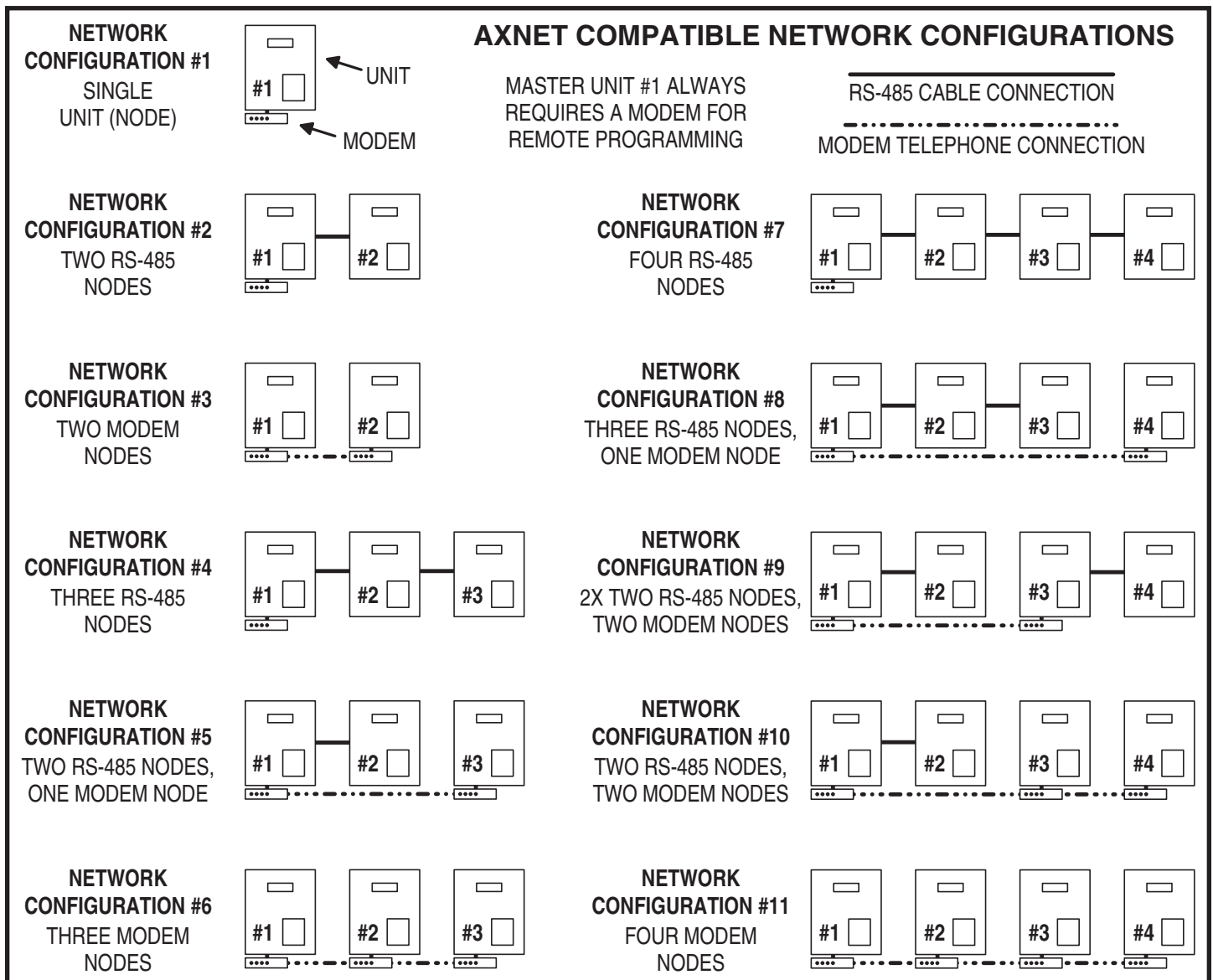

# Optional Network Connections (Continued)

## Network Configuration for AccessBase2000 Programming

If the system is going to be programmed using Linear's AccessBase2000 software, units communicate with each other on the network through RS-485 cable connections.

AccessBase2000 does not support unit-to-unit network communications through modems, only RS-485 cable. AccessBase2000 does support modem communications from the PC to the eight Node #1 "master" units on an AccessBase2000 network.

Refer to the figure below for design details of a fully implemented AccessBase2000 network. The figure shows eight networks, each with eight nodes, for a total of 64 units.

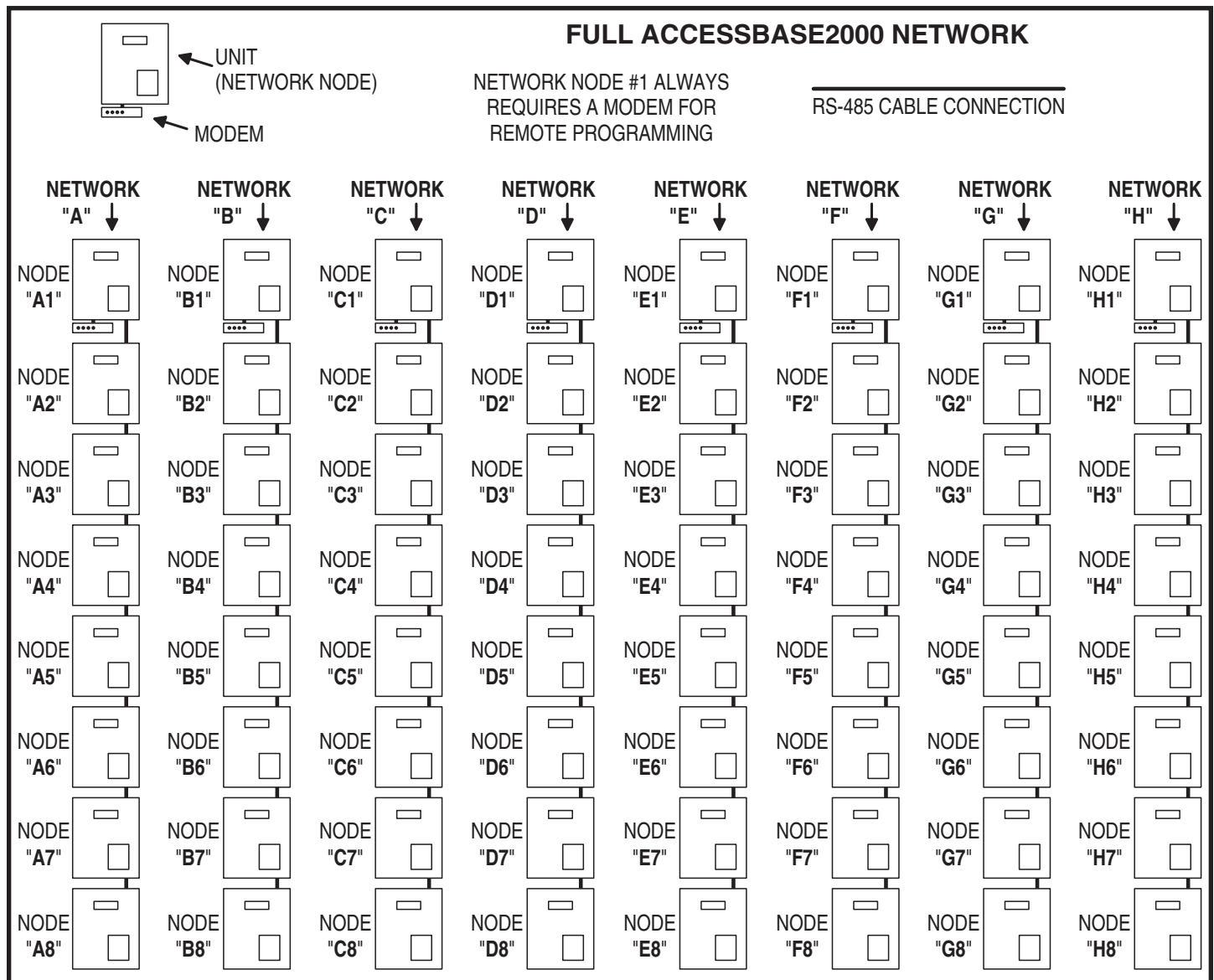



# Optional Network Connections (Continued)

## RS-485 Network Wiring

Network wiring conforms to 3-wire RS-485 electrical specifications. Units connected in the network can be wired using one unit as a "hub" or by wiring from one unit to the next in "daisy-chain" fashion. See the figures for wiring options.

- Use Belden 9925 or Carol C0600 shielded cable or equivalent. Maximum wire run distance is 4000 feet.
- ◆ **NOTE:** Be sure to connect the cable's shield to one of the GND terminals.

### Network Wiring with Hub

1. Mount and install the units for the network.
2. Choose one unit to be the Network Hub. Usually this would be a centrally located or "master" unit.
3. Route 3-conductor shielded cable from the hub unit to one of the other units. Repeat this step to connect the hub unit to each of the other units.
4. Connect the 3-conductor cable to each unit's **NETWORK** terminals.

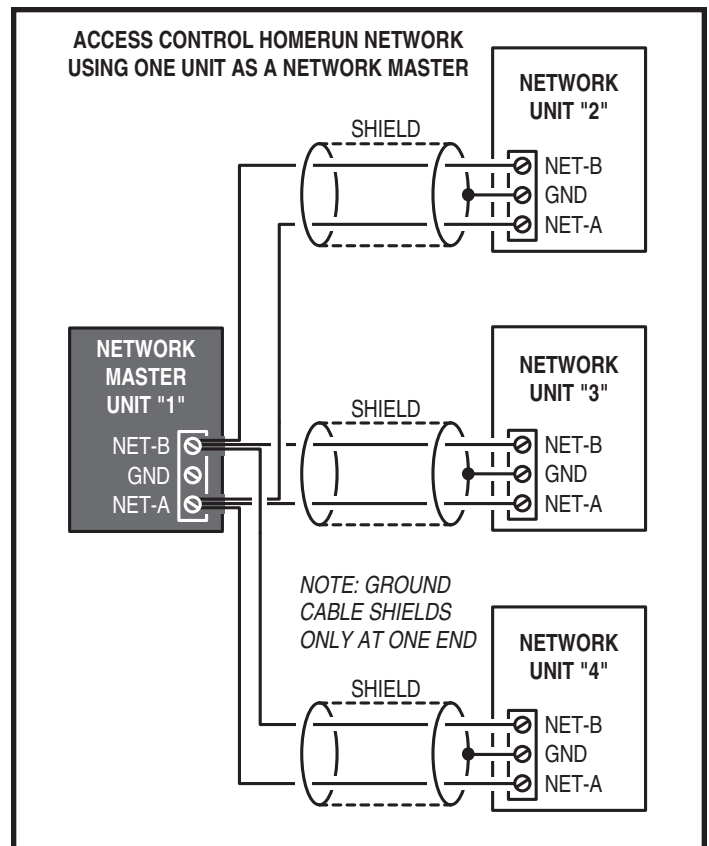

### Network "Daisy-chain" Wiring

1. Mount and install the units for the network.
2. Route 3-conductor shielded cable from one unit to the next until there is cabling run to all of the units.
3. Connect the 3-conductor cable to each unit's **NETWORK** terminals.

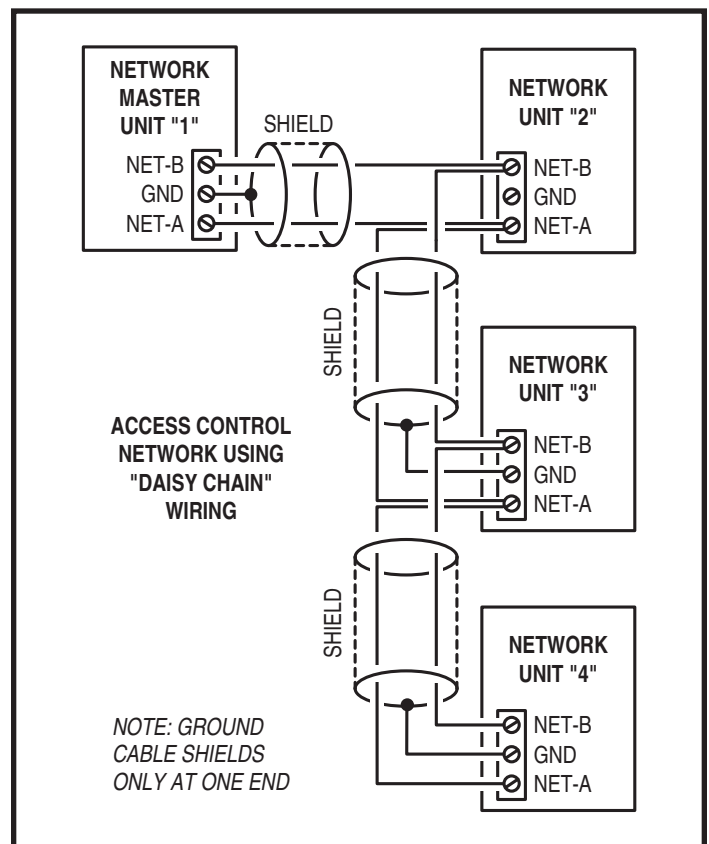

# System Adjustments

The factory settings are sufficient for most installations. The system can be adjusted to customize the installation.

## System Volume Adjustment

The sound level of the synthesized voice and key beep can be adjusted.

1. Locate the **SYSTEM VOLUME** adjustment on the CPU circuit board.
2. Press keys on the keypad while adjusting the control until the sound is at the desired level. Turn the adjustment *clockwise* for more volume, *counterclockwise* for less volume.

## 2-Way Audio Volume Adjustment

If the resident's voice from the speaker is too loud or not loud enough, the speaker's volume can be adjusted.



1. Locate the **2-WAY AUDIO VOLUME** adjustment on the CPU circuit board.
2. Make a directory number call to test the speaker volume. While listening to the resident's voice, turn the adjustment *clockwise* for more volume, *counterclockwise* for less volume.

## System Restart Button

Pressing the **SYSTEM RESTART** button will reboot the system's microcontroller. NO SYSTEM INFORMATION WILL BE ERASED.

## Display Contrast Adjustment

If the lighting in the area or the viewing angle of the display in the installation causes the display to look too dark or too light, the display's contrast can be adjusted.

1. Press the 1, 5 & 9 keys at the same time. The system will assume Contrast Adjustment Mode for 15 seconds.
2. Press the up and down arrow keys until display has the best visibility.
3. Press the  or  key to exit Contrast Adjustment Mode.

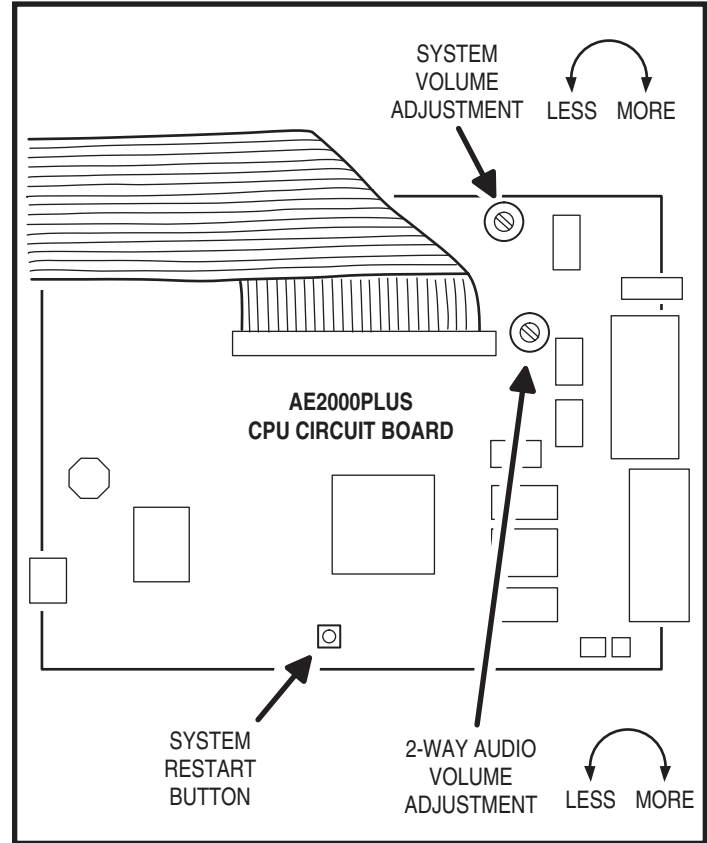

# System Diagnostics

Several components on the main circuit board are for monitoring the system during operation. When calling for technical assistance, Linear's Technical Services Department may ask the installer to use these components to diagnose the system.

## On-board Indicators

17 LED indicators are on the main circuit board. Refer to the figure for the location of each indicator.

- **STATUS/PROGRAM DISPLAY** shows supervisory and status conditions, also used for some local programming.
- **ACCESS GRANTED** lights when a credential is validated and access is granted.
- **HOST ON-LINE** lights when the Host PC is connected to the Master Node.
- **VALIDATE** lights when a credential is determined to be valid.
- **DECODE** lights when a credential has been successfully decoded.
- **RADIO** flashes when data or interference is received by the built-in radio.
- **RELAY "A" ACTIVE** lights when the Channel "A" relay is energized.
- **RELAY "B" ACTIVE** lights when the Channel "B" relay is energized.
- **RELAY "C" ACTIVE** lights when the Channel "C" relay is energized.
- **RELAY "D" ACTIVE** lights when the Channel "D" relay is energized.
- **POWER** lights when AC or DC power is present.
- **OFF-HOOK** lights when the system has the incoming telephone line seized.
- **TALK** lights when the system is communicating over the telephone line.
- **NETWORK** flashes in response to network traffic.
- **PBUS** blinks when any PBUS device is successively decoded.
- **READER "B"** flashes when Wiegand B device is successfully decoded.
- **READER "A"** flashes when Wiegand A device is successfully decoded.

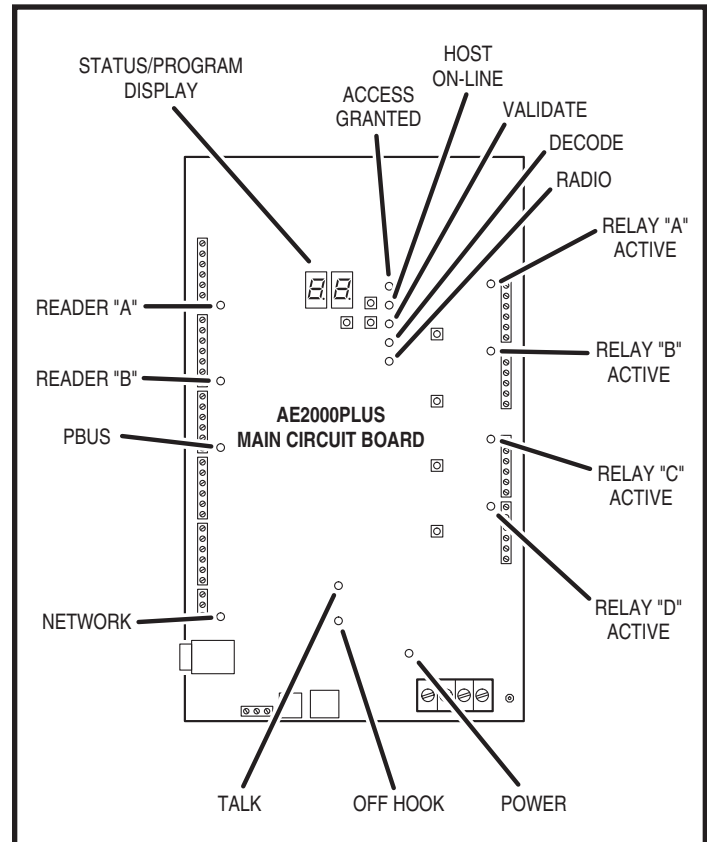

# Internal Controls

## On-board Pushbuttons

Seven pushbuttons are on the main circuit board. Refer to the figure for the location of each pushbutton.

- **UP** button adds one to the value on the STATUS/PROGRAM display.
- **DOWN** button subtracts one from value on the STATUS/PROGRAM display. Press with the **UP** button for one second to enter Programming Mode.
- **ENTER** button accepts the value on the STATUS/PROGRAM display during programming, clears an indication during the supervisory display.
- **RELAY "A" LATCH** press to latch relay "A", press again to unlatch.
- **RELAY "B" LATCH** press to latch relay "B", press again to unlatch.
- **RELAY "C" LATCH** press to latch relay "C", press again to unlatch.
- **RELAY "D" LATCH** press to latch relay "D", press again to unlatch.

## On-board Display

The STATUS/PROGRAM display shows the current system conditions and is used for system setup.

### Power-up

When power is applied, the display will show the current mode of operation (AXNET "Rn" or AccessBase2000 "Rb") and the version number of the firmware installed. The default mode of operation is AccessBase2000.

### Program Mode

Program Mode uses the display and the UP, DOWN, and ENTER pushbuttons. The setting the network node address, operation mode, and clearing the memory can be performed in Program Mode.

Refer to the following steps to change the system settings:

1. To enter Program Mode, press and hold the UP and DOWN pushbuttons together for one second. While in Program Mode, both decimal points on the display are lit.
2. The display shows the current network node number setting.
3. Press the UP or DOWN button to cycle the display through the options that can be selected (see Program Mode Display Table).
4. When the desired option is displayed, press the ENTER button to select the option.

◆ **NOTE:** In network installations, a unique network address (1-8 for AccessBase2000, 1-4 for AXNET) must be set before communicating with network.

◆ **NOTE:** If using AXNET for programming the system, select the Rn programming option, for AccessBase2000 select Rb.

After the option is selected, the system will restart.

### Status Mode

While the system is running, the display will show the current system status. Normally the left digit will show a moving pattern and the right digit will show the unit's Network Node number.

When a supervisory condition exists, the display will cycle to show the condition(s). When an item is displayed, press the ENTER button to clear the display (clears the display only, the condition may still exist). Refer to the following table for the supervisory condition display codes.

STATUS MODE DISPLAY	
DISPLAY	CONDITION
01	MGT TRANSMITTER STATUS EXCEPTION
02	MGT TRANSMITTER LOW BATTERY
03	MGT TRANSMITTER TAMPER
04	AC POWER FAIL (BACKUP BATTERY REQUIRED)
05	CHANNEL "A" LOCKED CLOSED
06	CHANNEL "B" LOCKED CLOSED
07	CHANNEL "C" LOCKED CLOSED
08	CHANNEL "D" LOCKED CLOSED
09	MODEM FAILURE

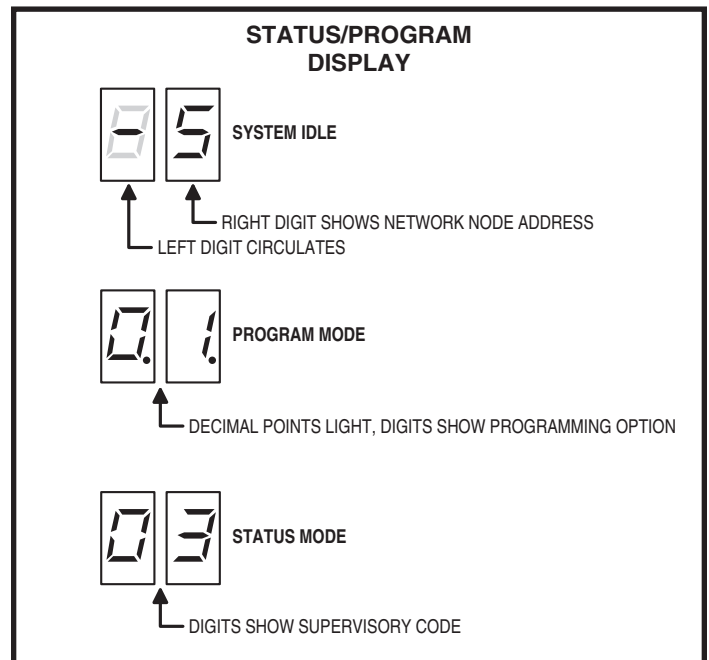
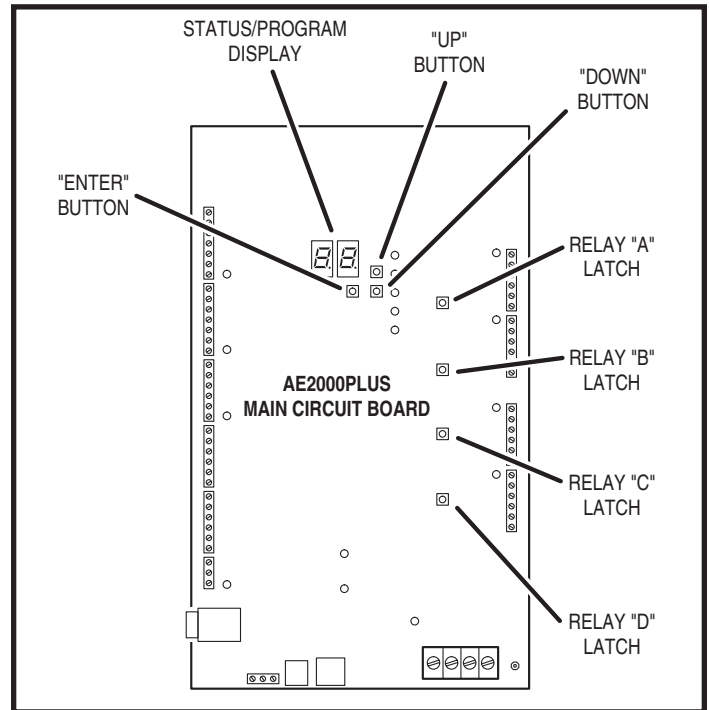



PROGRAM MODE DISPLAY		
AccessBase2000 MODE	AXNET MODE	FUNCTION
0.1.	0.1.	SET UNIT TO NODE #1
0.2.	0.2.	SET UNIT TO NODE #2
0.3.	0.3.	SET UNIT TO NODE #3
0.4.	0.4.	SET UNIT TO NODE #4
0.5.		SET UNIT TO NODE #5
0.6.		SET UNIT TO NODE #6
0.7.		SET UNIT TO NODE #7
0.8.		SET UNIT TO NODE #8
R.a.	R.b.	SWITCH OPERATION MODE
b.L.	b.L.	RESERVED (DO NOT USE)
c.L.	c.L.	CLEAR UNIT'S MEMORY

# AE2000Plus Operation

## Resident Access with an Entry Code



KEY IN AN ENTRY CODE AT THE SYSTEM KEYPAD OR ENTER A CODE AT A REMOTE KEYPAD

IF THE CODE IS ENTERED WRONG, PRESS THE  KEY TO RESET THE KEYPAD AND RE-ENTER THE CORRECT CODE (USE THE  KEY TO RESET REMOTE KEYPADS)

- OR -

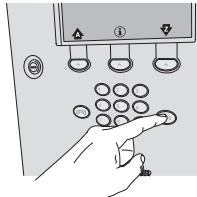
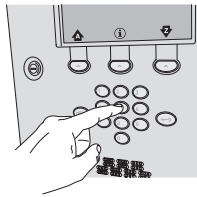
IF THE SYSTEM IS DISPLAYING THE DIRECTORY NAMES, PRESS THE  KEY FIRST, BEFORE KEYING IN AN ENTRY CODE



- Residents have up to 40 seconds to key in their entry code.
- Up to eight seconds are allowed between each keystroke.
- If the code is entered wrong, press the  key to reset the keypad and re-enter the correct entry code. (On remote keypads, press the  key to reset the keypad.)
- If the system is displaying the directory names, press the  key first, before keying in the entry code.
- After a correct code is entered, and if the conditions for granting access are fulfilled, the programmed relay will activate for the programmed time.
- If the number of incorrect codes entered exceeds the keypad lockout count, the keypad will be locked and not accept any entries for one minute.
- If the Anti-passback feature is enabled, the entry code will be unusable until the anti-passback time expires.

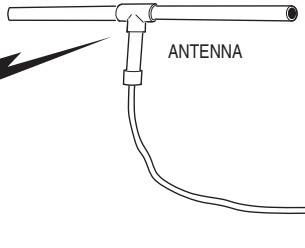

## Resident Access with a Wireless Transmitter

ACTIVATE TRANSMITTER





- Activate a wireless transmitter within radio range of the AE2000Plus's antenna.
- After a valid transmitter is decoded, and if the conditions for granting access are fulfilled, the programmed relay channel will activate for the programmed time.
- If the Anti-passback feature is enabled, the transmitter will become unusable until the anti-passback time expires.

## Visitor Access with a Resident Call

PRESS THE  KEY BELOW THE  OR  REPEATEDLY TO SCROLL THROUGH THE RESIDENT'S NAMES

- OR -

TO SCROLL THROUGH FASTER, PRESS AND HOLD THE  KEY BELOW  OR  THEN RELEASE THE KEY WHEN THE DESIRED LETTER IS UNDERLINED

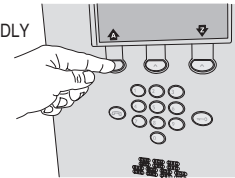

WITH THE RESIDENT DIRECTORY DISPLAYED, ENTER THE RESIDENT'S DIRECTORY NUMBER TO PLACE A TELEPHONE CALL TO THE RESIDENT

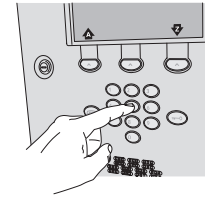

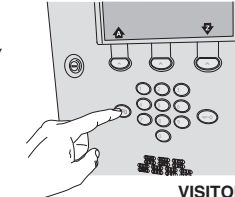

IF THE VISITOR ALREADY KNOWS THE RESIDENT'S DIRECTORY NUMBER, THEY CAN PRESS THE  KEY THEN ENTER THE DIRECTORY NUMBER WITHOUT VIEWING THE DIRECTORY DISPLAY

PRESSING THE  KEY DURING A TELEPHONE CALL WILL CANCEL THE CALL IN PROGRESS









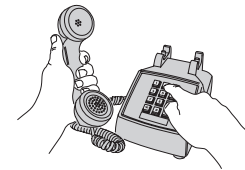



VISITOR

THE RESIDENT TALKS TO THE VISITOR AND CAN GRANT OR DENY ACCESS USING THEIR TELEPHONE KEYS

-  RELAY "A"
-  RELAY "B"
-  DISCONNECT



RESIDENT

- Press the  key below the  or  arrow repeatedly to scroll through the resident's names alphabetically and display their associated directory number.
- To scroll through the alphabet faster and choose which letter to view, press and hold down the  key below the  or  arrow. Release the key when the desired letter is underlined.
- With the resident directory displayed, the visitor enters the directory number to place a call to the resident.
- If the visitor already knows the resident's directory number, they can press the  key then enter the directory number without viewing the directory display.
- The system will dial the resident's telephone number to establish 2-way communications.
- ◆ **NOTE:** The resident's telephone number will never be displayed to the visitor.
- If the resident is using the telephone at the same time a visitor calls, the system will indicate to the visitor that the line is busy.
- The resident answers the call and converses with the visitor to determine if access will be granted.
- The resident can use their telephone's keypad to grant access activating Relay Channel "A" by pressing  or activating Relay Channel "B" by pressing . After access is granted, the system will disconnect the visitor and resident call.
- The resident can disconnect the visitor without granting access by pressing  or by hanging up.
- ◆ **NOTE:** The telephone keys that the resident presses can be customized for the installation.
- The length of time the visitor is allowed to talk can be programmed from 15-255 seconds. The resident will hear a series of beeps during the last 10 seconds of talk time. To restart the talk timer, the resident can press  on their telephone.

# Specifications

## MECHANICAL

Case dimensions: 15-1/4" W x 19" H x 4" D

## ELECTRICAL

Voltage: 16-24 Volts AC or 12-24 Volts DC

Current: 2000 mA @ 16 VAC maximum

Backup Battery: Externally charged 12 Volt DC source, 6 amp/hr minimum

Outputs: Relay Channels A-D

Form "C" 3 Amps @ 30 Volts maximum

Inputs: Four normally closed door sense inputs

Four normally open exit request inputs

Two WIEGAND reader inputs

Three PBUS inputs

Network: Three-wire network

## RADIO

Frequency: 318 MHz  $\pm$  500 KHz @ 23°C

Bandwidth: 300 KHz Typical

Sensitivity: -97 dBm Minimum (-100 dBm Typical)

Encoding: Linear MegaCode® Format

## ENVIRONMENTAL

Temperature: -22°F to 149°F (-30°C to 65°C)

Humidity: 5% to 95% non-condensing

# Dimension Drawing

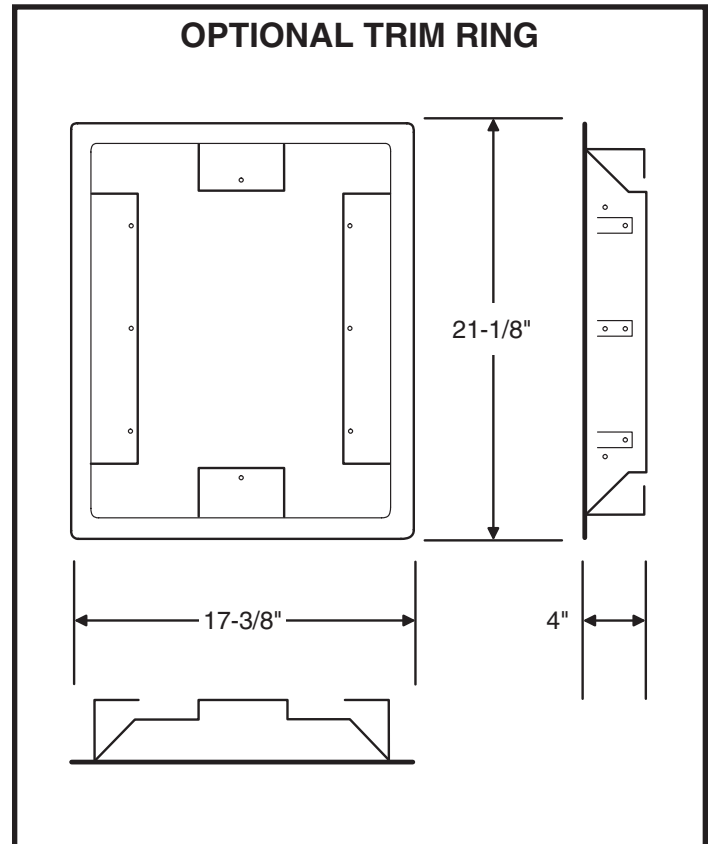
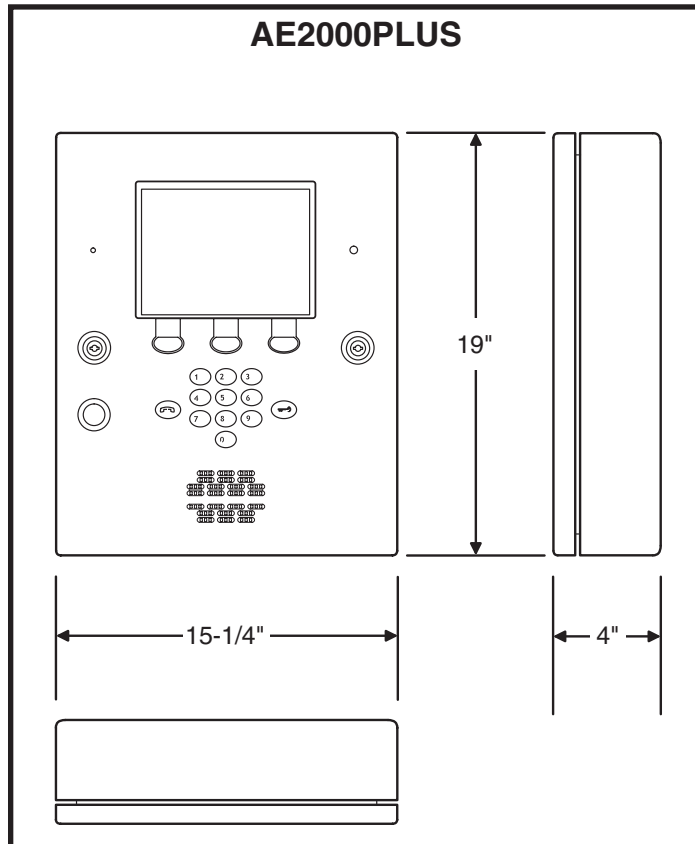

---

# Troubleshooting

## System completely dead

1. No power from transformer. Check voltage at transformer terminals.
2. Check voltage at AE2000Plus power terminal strip.

## Buzz on speaker

1. Check for 24 volt AC power shorted to wiring conduit.
2. Check for telephone line shorted to ground.
3. Verify that telephone wires are twisted pair.
4. Verify that the AE2000Plus is connected to earth ground.
5. Check 16 VAC voltage at AE2000Plus transformer terminals.

## Buzz on telephone line

1. Disconnect 16 VAC wires from terminal strip, if buzz goes away, one side of the transformer wires is grounded.
2. Check all connections for any shorts to ground.

## System will not answer an incoming call

1. Automatic telephone answer disabled.
2. AE2000Plus telephone line trouble.

## Entry code will not activate relay

1. Entry code not assigned.
2. Entry code not set up for proper relay.
3. Keypad is in lockout.

## Remote PBUS device does not work

1. Check remote device address switch setting.
2. Check remote device for power.
3. Be sure the device is wired correctly.

## Main or remote keypad will not activate a relay

1. Entry code is not assigned.
2. Keypad may be in lockout from too many incorrect attempts. Wait one minute for lockout to clear and try again.
3. Remote keypad wiring incorrect.

## Resident's Telephone does not ring when a visitor calls

1. Resident's telephone number programmed incorrectly.
2. Check AE2000Plus telephone line.
3. Call resident from another line or cell phone to determine if the resident's telephone is working.

## Transmitter does not activate relay

1. Transmitter button setting programmed to "none" (would effect all transmitters).
2. Transmitter not enrolled.
3. Specific transmitter is deactivated in the system.

## Poor transmitter radio range

1. Check antenna installation and condition if transmitters were previously working well.
2. Check the **RADIO** indicator on the AE2000Plus circuit board. If it is flickering without activating any transmitters there is interference blocking the receiver. Try adjusting the **RECEIVER RANGE** knob to reduce the receiver's sensitivity to the interference.
3. Connect an audio amplifier or telephone buttset to the **RECEIVER TEST POINTS** (the wire jumpers next to the **RECEIVER RANGE** knob). Listen to the sounds of the signals being received. If you hear the interference, remove power from possible interfering devices to determine the source of the interference. The antenna or the interfering device may need to be relocated.
4. Use Model FT-1 to check for interference.

---

## Linear Limited Warranty

This Linear product is warranted against defects in material and workmanship for twenty-four (24) months. This warranty extends only to wholesale customers who buy direct from Linear or through Linear's normal distribution channels. Linear does not warrant this product to consumers. Consumers should inquire from their selling dealer as to the nature of the dealer's warranty, if any. **There are no obligations or liabilities on the part of Linear LLC for consequential damages arising out of or in connection with use or performance of this product or other indirect damages with respect to loss of property, revenue, or profit, or cost of removal, installation, or reinstallation.** All implied warranties, including implied warranties for merchantability and implied warranties for fitness, are valid only until the warranty expires. **This Linear LLC Warranty is in lieu of all other warranties express or implied.**

All products returned for warranty service require a Return Product Authorization Number (RPA#). Contact Linear Technical Services at 1-800-421-1587 for an RPA# and other important details.

---

## FCC Notice

Changes or modifications not expressly described in this manual or approved by the manufacturer could void the user's authority to operate the equipment.

This equipment has been tested and found to comply with the limits for a Class B digital device, pursuant to Part 15 of the FCC Rules. These limits are designed to provide reasonable protection against harmful interference in a residential installation. This equipment generates, uses and can radiate radio frequency energy and, if not installed and used in accordance with the instructions, may cause harmful interference to radio communications. However, there is no guarantee that interference will not occur in a particular installation. If this equipment does cause harmful interference to radio or television reception, which can be determined by turning the equipment off and on, the user is encouraged to try to correct the interference by one or more of the following measures:

- Reorient or relocate the receiving antenna.
- Increase the separation between the equipment and receiver.
- Connect the equipment into an outlet on a circuit different from that to which the receiver is connected.
- Consult the dealer or an experienced radio/TV technician for help.

**Linear**  **ACCESS** <sup>TM</sup>