

APOLLO *Gate Operators, Inc.*

Model 700ETL

**Post Mounted Residential & Medium Duty Commercial
Slide Gate Operator**

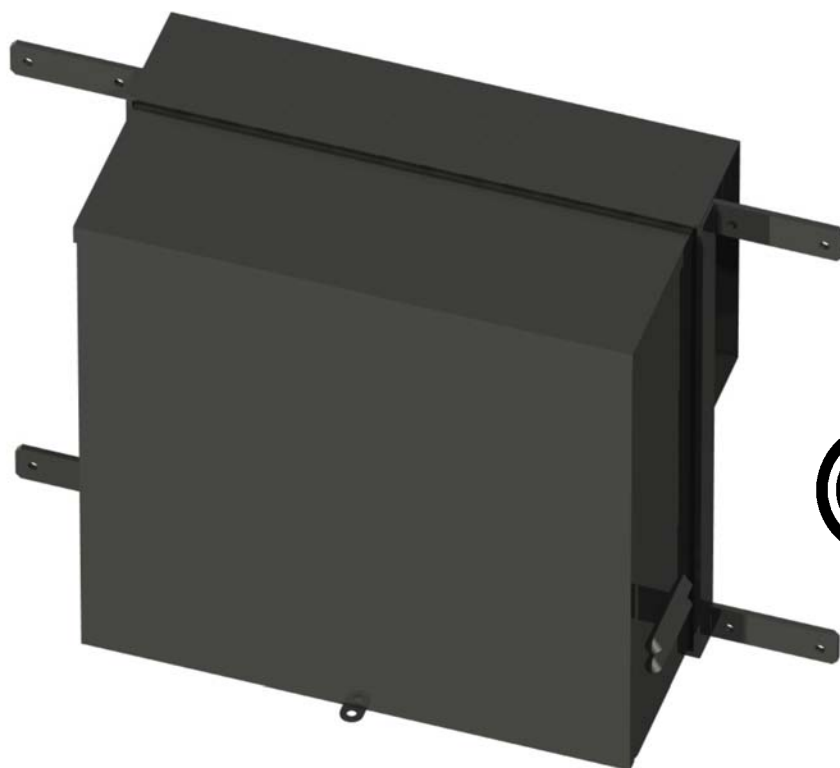

INSTALLATION MANUAL

CONTENTS

IMPORTANT SAFETY INSTRUCTIONS	3
Applications	4
Pre-Installation Checklist	5
Parts Identification	6
Operator Installation	7
Chain Bracket Installation	8
Chain & Chain Bolt Installation	8-9
Chain Magnets Installation	9
Gate Limit Switch Installation	10
Quick Release Operation	10
Programming Current Sensing	11
835/836 Control Board	12-16
Siren Connection	17
Radio Receiver Options	18
Warranty	19

IMPORTANT SAFETY INSTRUCTIONS

WARNING - To reduce the risk of injury or death:

- **READ AND FOLLOW ALL INSTRUCTIONS.**
- Installation should be performed by a professional installer.
- Required welding should be performed by a qualified welder.
- Should electricity be required, use a certified electrician only.
- Any device that requires 120 Volts AC should be U.L. approved.
- Review with the owner all safety concerns including:
 - ⇒ Do not operate the gate unless area around gate is in full view.
 - ⇒ Never let children operate or play with gate controls. Keep the remote control away from children.
 - ⇒ Always keep people and objects away from the gate. **NO ONE SHOULD CROSS THE PATH OF THE MOVING GATE.**
 - ⇒ Periodically test the obstruction sensitivity to assure safe and proper operation. *Do not test sensitivity by standing between the gate and the hinge or stop post.*
 - ⇒ The “CAUTION AUTOMATIC GATE” signs should be clearly visible from both sides of the gate.
 - ⇒ Always insure that the gate has closed securely before leaving area.
 - ⇒ Arrange with local fire and law enforcement for emergency access.
- Use the emergency release only when the gate is not moving.
- A secondary entrapment device such as loop detectors, edge switches, and beam detectors are highly recommended and required to meet the UL325 standard.
- Install control devices such as keypads far enough away (5 feet or further) from any moving parts of the operator and gate to prevent possible injury.
- Do not install control box where the gate can come in contact with person using the push button on side of control box.
- Always disconnect the battery or power source when making adjustments or repairs to any part of the gate or operator.
- All rollers should be covered to prevent injury.
- **KEEP GATES PROPERLY MAINTAINED.** Read the owner’s manual. Have a qualified service person make repairs to gate hardware.
- The entrance is for vehicles only. Pedestrians must use separate entrance.

Test the gate operator monthly. The gate **MUST** reverse on contact with a rigid object or stop when an object activates the non contact sensors. After adjusting the force or limit of travel, retest the gate operator. Failure to adjust and retest the gate operator properly can increase the risk of injury or death.

SAVE THESE INSTRUCTIONS.

APPLICATIONS

The **Apollo** Model 7000ETL Slide Gate Operator is designed to handle a slide gate up to 22 feet in total length (accommodates a 20 foot drive) and 600 Lbs. A professional fence or gate dealer is recommended to assure proper installation.

Apollo Gate Operators are available only through qualified dealers with an outstanding reputation in the fence and gate industry. These dealers will be able to recommend the proper equipment for particular applications. **Apollo Gate Operators** are 12 Volt DC (*Direct Current*) powered. A 12 Volt 33 ampere hour (minimum) sealed battery is recommended. There are several advantages with 12 Volt DC systems:

- **Low voltage virtually eliminates risk of electrical shock.**
- **Battery powered operators can provide up to 200 operations in the event of power outages.**
- **The battery may be recharged with a trickle charger or by solar energy (Electrical battery chargers should have a class 2 transformer rating).**

If a trickle charger is used and a standard electrical outlet is not readily available, a licensed electrician will be required for proper electrical hook up.

The following table should be used as a guide for capacity of operation of operators only, additional options may reduce the the daily usage. *Please note that the charge capability of solar panels will vary with different geographical locations.*

Daily Cycles →	1-10	1-20	1-40	1-60	1-80	80+
5 watt solar panel	*					
10 watt solar panel		*				
20 watt solar panel (<i>requires 5310 regulator</i>)			*			
30 watt solar panel (<i>requires 5310 regulator</i>)				*		
40 watt solar panel (<i>requires 5310 regulator</i>)					*	
1.5 amp battery charger					*	
10 amp battery charger						*

Note: Double the amount of solar panels for Dual Gate Operators.

PRE-INSTALLATION CHECKLIST

The following checklist should be used before beginning installation:

- **Verify that the proper operator has been selected for this application.**
- **Verify proper installation and operation of the gate.**
 1. *Are all rollers covered with a protective housing?*
 2. *Are the rollers servicable?*
 3. *Does the gate roll free and level?*
 4. *Will the gate require a locking device?*
 5. *Are the main posts sturdy enough to handle the gate & operator?*
- **Determine the general location of the operator, chain brackets, and solar panel (if used).**
 1. *Is there a suitable location for the operator?*
 2. *Can the solar panel (if used) be mounted in an unobstructed area facing south?*
 3. *Will additional solar panel cable be required?*
 4. *Is electricity available (if required)?*
- **Consider safety and access options. Recommend if needed.**
 1. *Will there be children or animals in the area?*
 2. *Are safety loops, edge switches, or photo beam detectors required?*
 3. *How can the gate be opened in emergencies?*
 4. *How will visitors enter and exit?*
 5. *Will vehicles (and trailers) have sufficient room off roadway to operate any control devices such as keypads?*

PARTS IDENTIFICATION

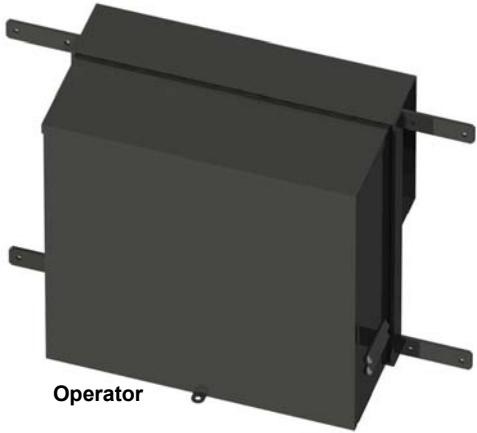

Operator

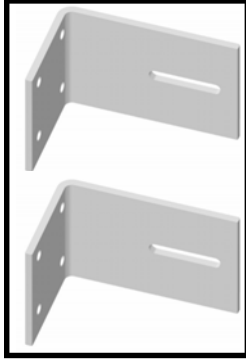

Chain Brackets (2)

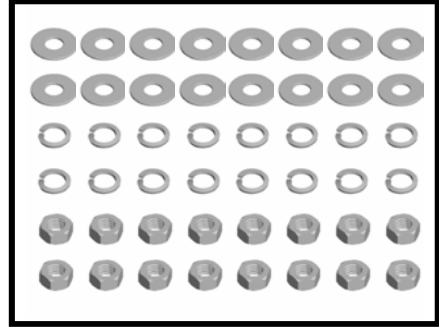

5/16 Washers, Lock Washers, & Nuts (16 each)

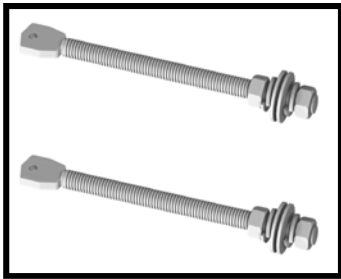

Chain Bolts with hardware (2 each)

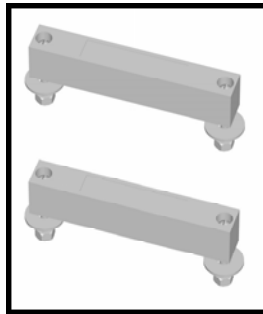

Magnetic Chain Limits with hardware (2 each)

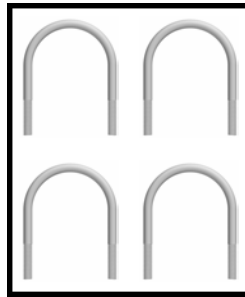

5/16" x 2" U Bolts (4 each)

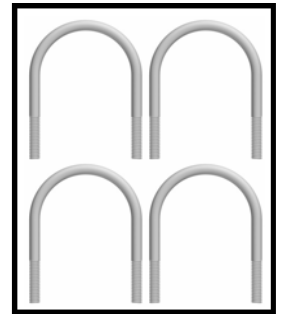

5/16" x 3" U Bolts (4 each)

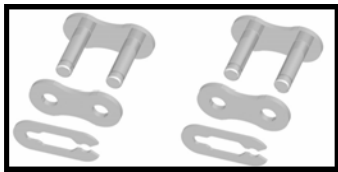

Master Chain Links (2 each)

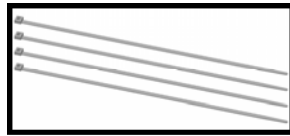

Tie Wraps (4 each)

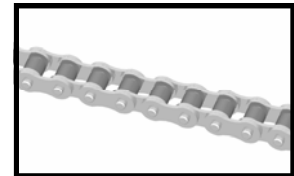

#40 Roller Chain (35 feet)

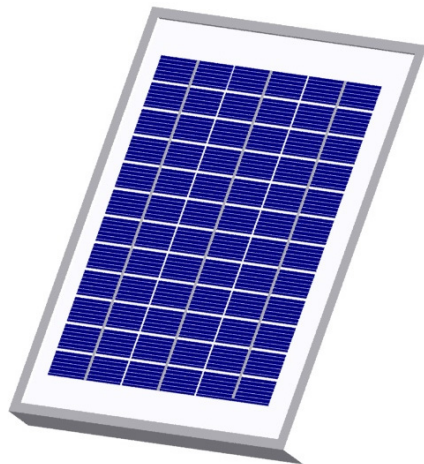

#201
5 Watt Solar Panel & Bracket (optional)



#404C
Automatic Battery Charger (optional)



#273G
CAUTION Signs (2 each)

OPERATOR INSTALLATION

STEP 1. Install two 3" dia. Posts parallel to the gate as shown. Posts height depends on height preference of operator.

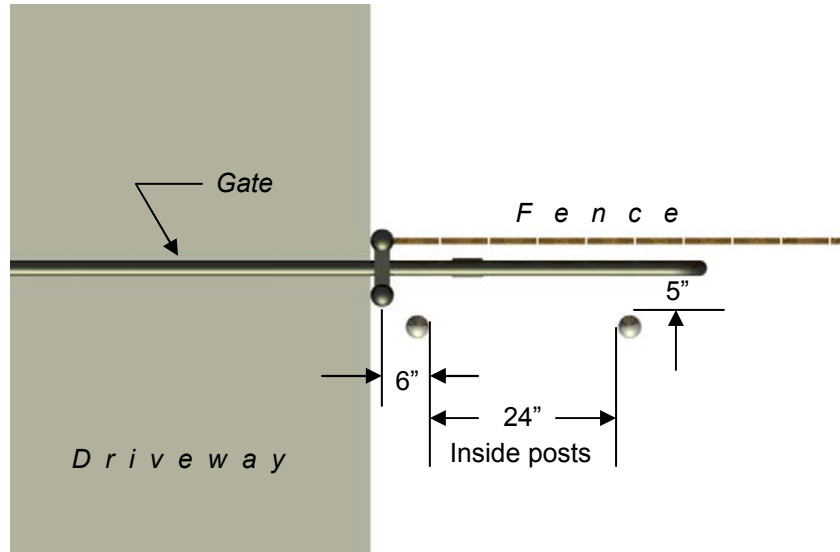

STEP 2. Remove chain cover and front lid. Mount to posts using the four supplied 3" U-bolts



STEP 3. Install one of the gate brackets and chain bolts on right side of gate using the supplied 2" U-bolts. Do not tighten at this time.

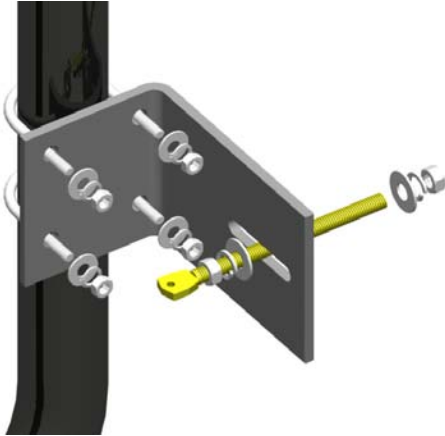

STEP 4. Attach the chain to the chain bolt using the master chain link.

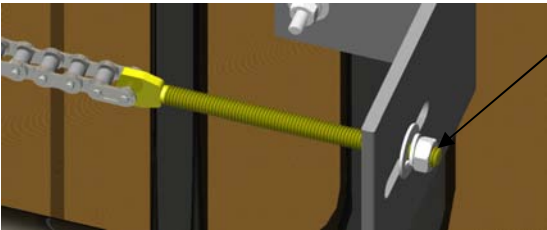
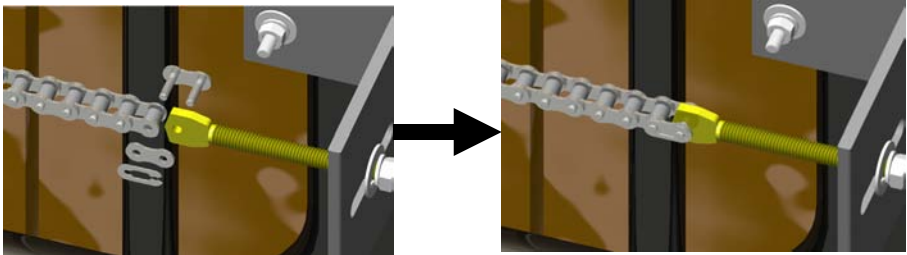

Adjust the chain bolt to allow for maximum tightening

Note: The height of the chain bolt should align with the bottom teeth of the idler sprockets.

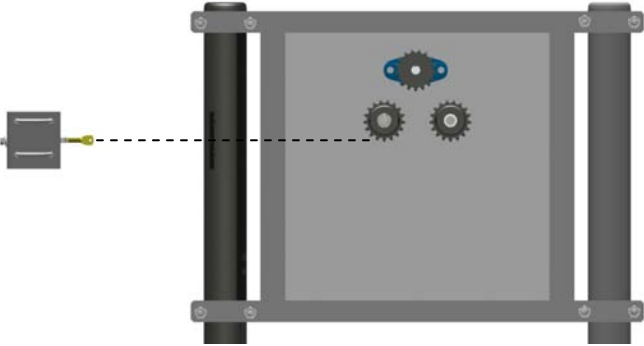

STEP 5. Thread chain on the sprockets as shown.

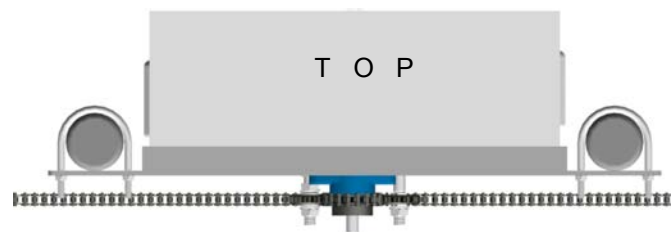
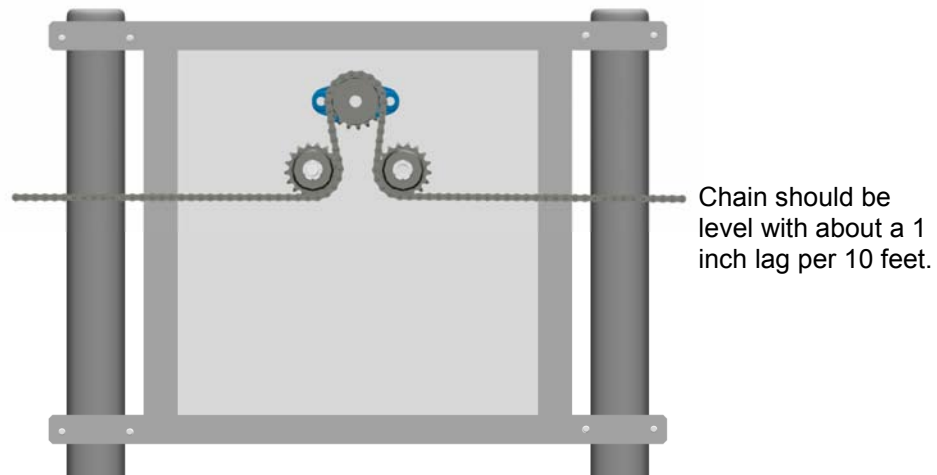

Chain should be aligned with all sprockets.

STEP 6. (Refer to page 8)

Install the other gate bracket and chain bolt on the left side of the gate.

Determine the required length of chain needed to attach to the chain bolt and still allow adjustment.

Using a chain breaking tool, remove excess chain.

Attach chain to chain bolt.

Tighten all chain brackets and chain bolts. Allow 1 inch of chain lag per 10 feet of chain.

GATE LIMIT SWITCH INSTALLATION

Align each magnet with the corresponding switch on the operator for the open and closed position.

Connect the battery and test for proper open & close position.

WARNING : If further adjustment is required, always disconnect battery prior to relocating the chain magnet.

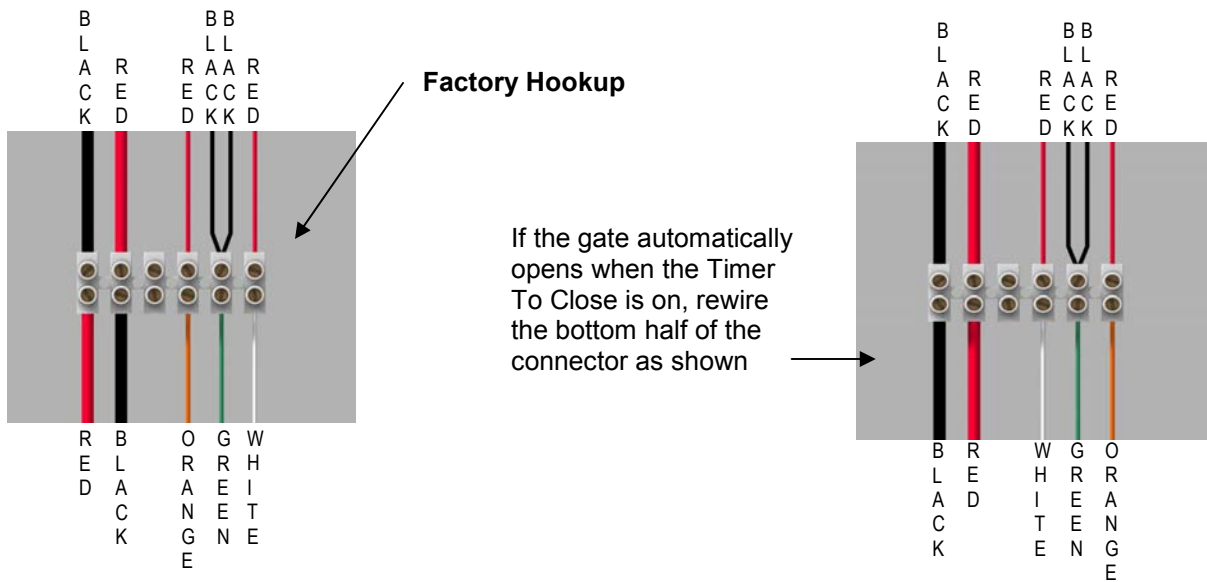
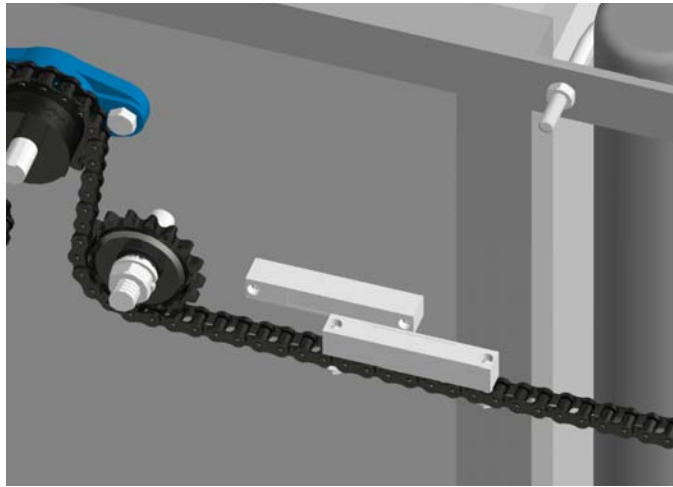

STEP 7. Install chain cover.
 Install solar panel or battery charger and any optional accessories.
 Close box.
 Good Job!

QUICK RELEASE OPERATION

Gate may be manually opened using the quick release.

Disconnect battery before use!

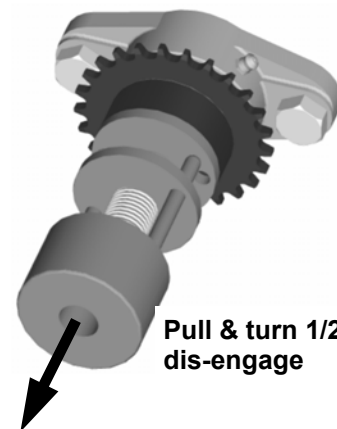

STEP 7 Programming Current Sensing

The **835/836** control boards incorporate a safety feature that will put the operator into a hard shutdown mode if the control board detects a current sense two consecutive times during a cycle. This hard shutdown condition can only be reset by shorting the **FIREBOX** or **UL** connectors on the left side of the control board to ground. This condition may also be reset by pressing the **HARD SHUTDOWN RESET** button located toward the upper right hand corner of the control board. If a firebox (optional) is used in the installation, the firebox door should be opened and closed to reset the control board.

The following instructions must be followed at installation for proper safety assurance. All limits should be set before beginning this procedure.

This new procedure applies to revision **31** or higher firmware.

1. Press and hold the **LED ENABLE** button for five seconds. The **STOP LED** will blink indicating that the board is in learn mode.
3. Cycle gate for 3 full cycles. The **STOP LED** will stop blinking indicating that the board is now ready for normal operation
4. Test the auto reverse sensitivity to ensure maximum safety protection. The current sensitivity adjustment pot may be adjusted to decrease or increase sensitivity.

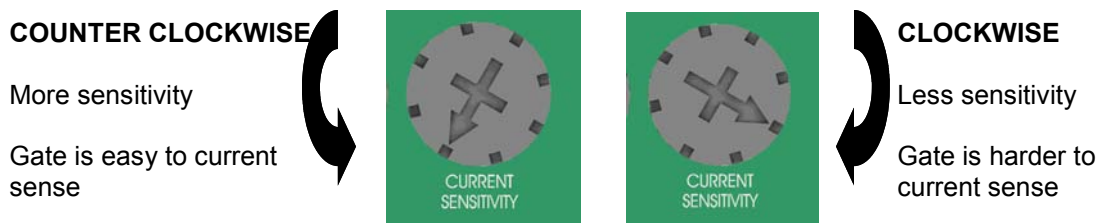

8. Refer to the **835/836 Operator Control Board Manual** to set other options such as program switch options and close timer adjustments.

Installation is now complete.

Note: Program switch #9 is no longer functional and the current sense may be readjusted at any time.

835/836 Control Board Parts Identification

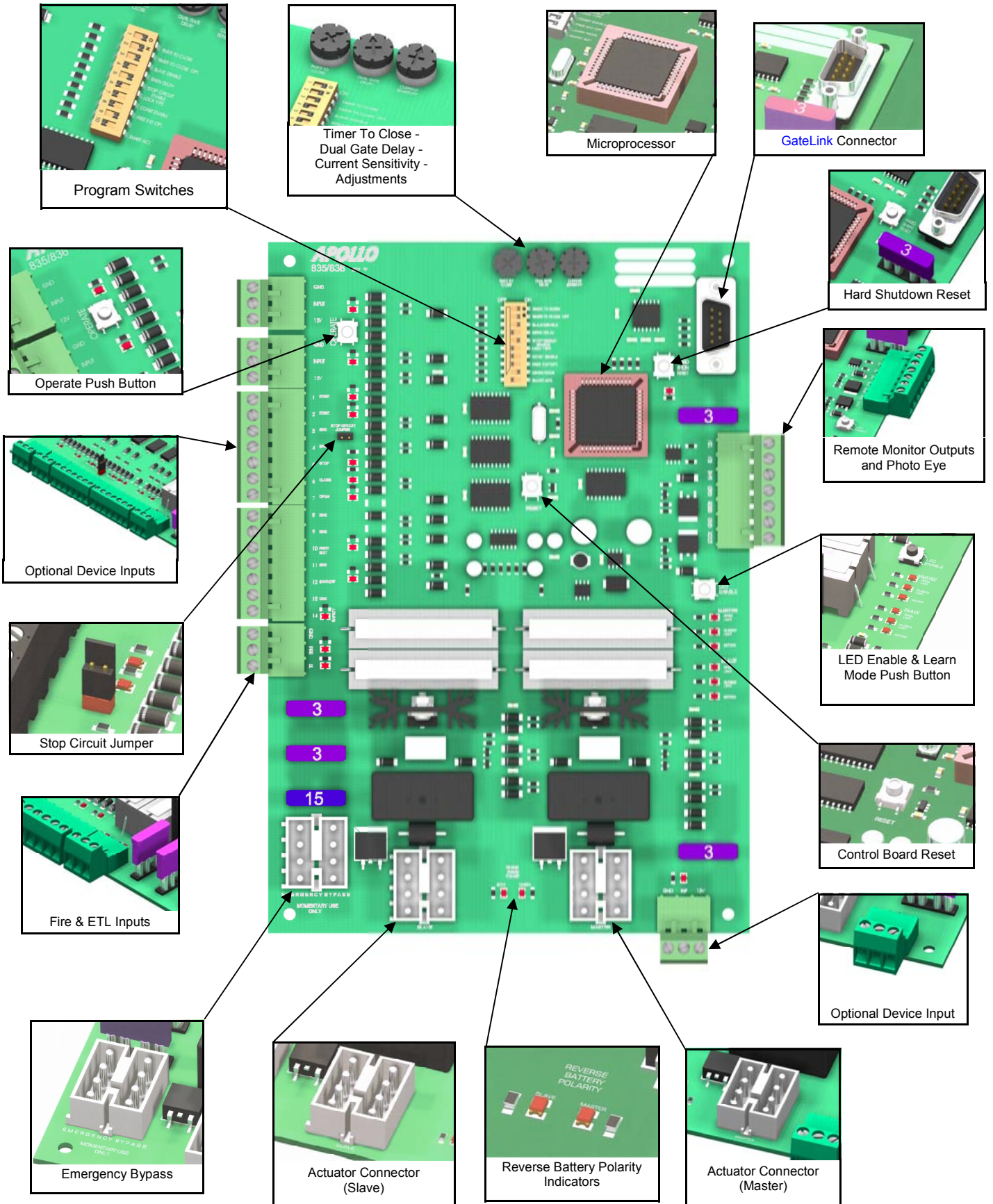

Actuator Connector

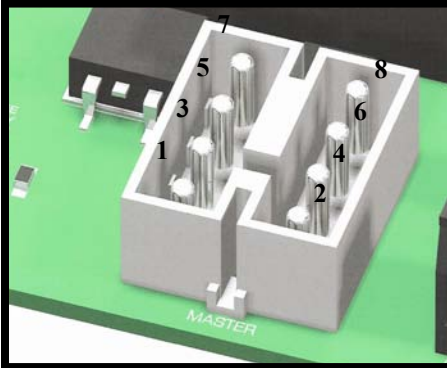

Board	Actuator Cable	Function
Pin 1	Orange	Open Limit
Pin 2	White	Close Limit
Pin 3	Black	Motor (positive on open, negative on close)
Pin 4	Red	Motor (negative on open, positive on close)
Pin 5	Green	Common for both limit switches
Pin 6	Yellow	Feedback from intelligent actuator(816E/816EX)
Pin 7	Black	Battery Negative
Pin 8	Red	Battery Positive

EMERGENCY BYPASS (open only)

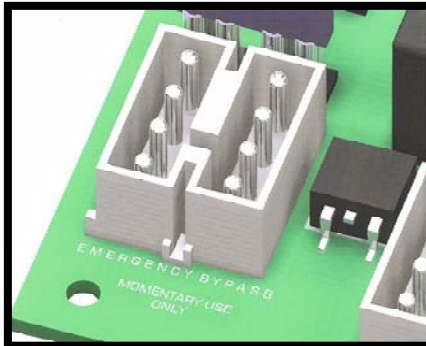

Applies battery voltage directly to motor to open gate if control board fails. User must unplug before gate opens to maximum travel or 15 amp fuse will open. Fuse should be checked before returning gate to service.

Remote Outputs and Photo Eye Hookup



12V	Supplied battery voltage
MAS	Master Operator Indicator (indicates master side of gate is closed) +12V when on closed limit. Ground when off of closed limit.
SLV	Slave Operator Indicator (indicates slave side of gate is closed) +12V when on closed limit. Ground when off of closed limit.
GND	Battery supplied ground
SIREN	Connect to siren + applies +12V when gate(s) are running, or in hard shutdown
GND	Battery supplied ground
LOCK	Connect to lock + (optional) Magnetic or Solenoid type locks (Dip Switch #6 Selectable)

Photo Eye Hookup



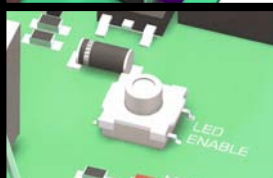



Photo eye / safety loop wiring. Connect the positive power wire of the accessory to 12V. Connect the ground wire of the accessory to MAS (upper right area of the 835/836 board). Connect the relay wires of the accessory as normal: COM to GND. NO to SAFETY (#14) (for a safety device). When the gate operator begins opening (comes off of the closed limits) the MAS terminal will become a ground and will complete the flow of power to the accessory. This will power the accessory up and it will work as normal until the gate gets closed and the MAS terminal switches and the device will power down.

Adjustments

	<p>TIMER TO CLOSE Adjusts time before gate automatically closes. Adjustable 5 to 70 seconds.</p>
	<p>DUAL GATE DELAY Adjusts delay between master and slave operation 0-4 seconds (836 only for use with magnetic, solenoid, and other locking devices)</p>
	<p>CURRENT SENSITIVITY Increases or decreases the Auto Reverse sensitivity.</p>

Push Buttons

	<p>OPERATE When depressed, activates the gate. Used for initial installation and testing.</p>
	<p>Hard Shutdown Reset Resets the operator when the gate current senses twice before fully opening or closing.</p>
	<p>LED ENABLE When depressed, activates LEDs for 15 minutes to assist in installation and troubleshooting.</p> <p>Hold the push button down for five seconds to put the board in program mode.</p>
	<p>RESET Resets the microprocessor. Returns processor to last known state.</p>

Jumpers

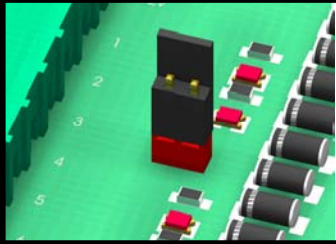
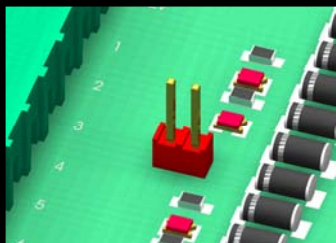

	<p>STOP CIRCUIT JUMPER When the STOP CIRCUIT JUMPER is connected, the gate will operate normally.</p> <p>program switch #5 must be ON</p>
	<p>STOP CIRCUIT JUMPER When a 3-button station is connected to the board, the STOP CIRCUIT JUMPER must be removed.</p> <p>program switch #5 must be OFF</p>

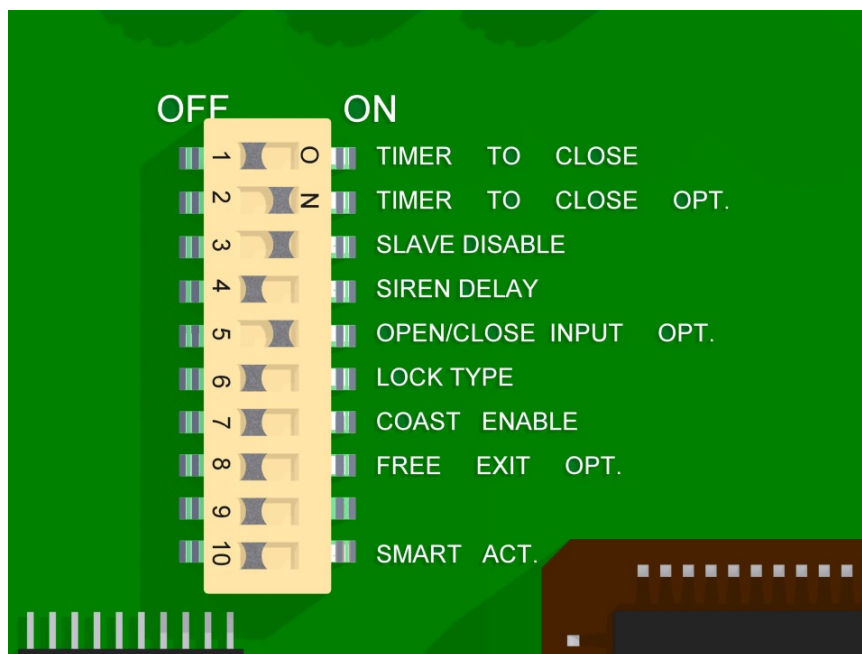
Program Switches

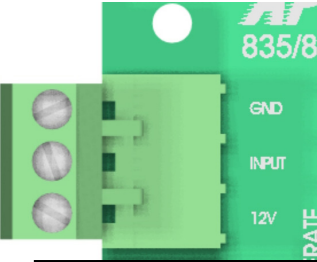

	OFF	ON
1 TIMER TO CLOSE	Gate does not automatically close.	Gate automatically closes.
2 TIMER TO CLOSE OPT.	Gate automatically closes from any position after opening.	Gate automatically closes only when completely open (open limit engaged).
3 SLAVE DISABLE	Enables slave side (dual gate use).	Disables slave side. (single gate use)
4 SIREN DELAY	Siren (optional) active when gate is moving.	Siren (optional) starts 5 seconds before gate moves.
5 'STOP' CIRCUIT ENABLE	Must hold down open or close buttons to move gate. Gate stops when button released.	Normal operation Momentary open or close input runs gate to limit.
6 LOCK TYPE	For 12V mechanical (solenoid) locks. <i>(+12V for 4 seconds on open cycle)</i>	For 12V magnetic locks. <i>(+12V when on close limit)</i>
7 COAST ENABLE	Gate will stop immediately when at Open or Close limit	Gate will coast (minimally) when it reaches limits. Recommended for 7500 slide operator only.
8 FREE EXIT OPT.	A free exit input will open gate from closed position or after a close cycle only.	A free exit input will open gate from any position after an open or close cycle.
9 DUAL GATE SYNC	Both gates operate at normal Speed (slave slower than Master).	This feature will control the master gate to open or close at the same speed as the slave gate.
10 SMART ACT.	Off for 416E & 416EX actuators, slide gates, 3500 or when slow down feature is not desired.	Used for 816E & 816EX actuators only (soft start & stop).

Optional Device Inputs

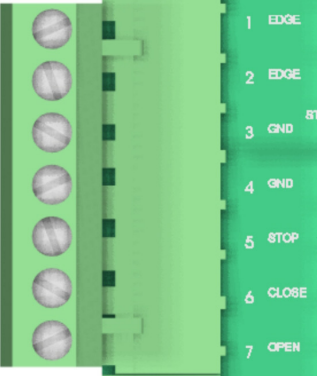
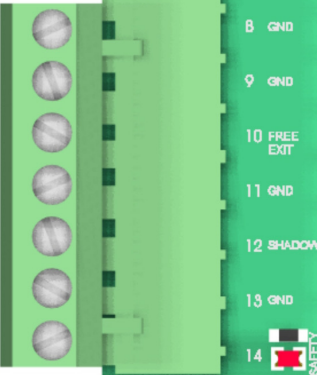
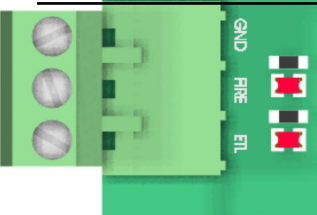
	835/8 GND	GND	Supplied Battery Ground
	INPUT	INP	Activate Gate (Push button activation when momentarily shorted to ground)
	12V	12V	Supplied Battery Voltage (Protected with 3 Amp fuse)
	GND	GND	Supplied Battery Ground
	INPUT	INP	Activate Gate (Push button activation when momentarily shorted to ground)
	12V	12V	Supplied Battery Voltage (Protected with 3 Amp fuse)
	1 EDGE	EDGE	Reverse edge input. When grounded, will stop and reverse gate if closing, resets close timer if gate is open.
	2 EDGE	EDGE	Reverse edge input. When grounded, will stop and reverse gate if closing, resets close timer if gate is open.
	3 GND	GND	Supplied Battery Ground
	4 GND	GND	Supplied Battery Ground
	5 STOP	STOP	Stop input from a 3 button station (must remove STOP CIRCUIT JUMPER) Normally closed
	6 CLOSE	CLOSE	Close input from a 3 button station (see program switch #5 for options)
	7 OPEN	OPEN	Open input from a 3 button station (see program switch #5 for options)
	8 GND	GND	Supplied Battery Ground
	9 GND	GND	Supplied Battery Ground
	10 FREE EXIT	FREE EXIT	Opens gate if closed, stops and reverses gate if closing, resets close timer if gate is open.
	11 GND	GND	Supplied Battery Ground
	12 SHADOW	SHADOW	Resets close timer when gate is open (also referred to as under gate loop)
	13 GND	GND	Supplied Battery Ground
	14 SAFETY	SAFETY	Resets close timer if gate is open, stops and reverses if gate is closing. (Does not open a closed gate)
	GND	GND	Supplied Battery Ground
	FIRE	FIRE	When grounded, opens gate and holds gate open until released. Clears "Hard Shutdown" mode of software.
	UL	UL	When grounded, opens gate and holds gate open until released. Clears "Hard Shutdown" mode of software.

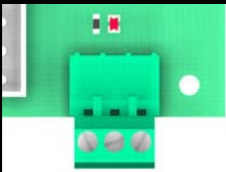
	GND	GND	Supplied Battery Ground
	INPUT	INP	Activate Gate (Push button activation when momentarily shorted to ground)
	12V	12V	Supplied Battery Voltage (Protected with 3 Amp fuse)

APOLLO *Gate Operators* RECEIVER OPTIONS

Do not confuse the receiver code switches with the red program switches on the gate control board.

Never set all code switches to the same position. Transmitters must match code switches for proper operation.

If power is taken directly from battery or connected as shown below, receiver should be configured for 12VDC

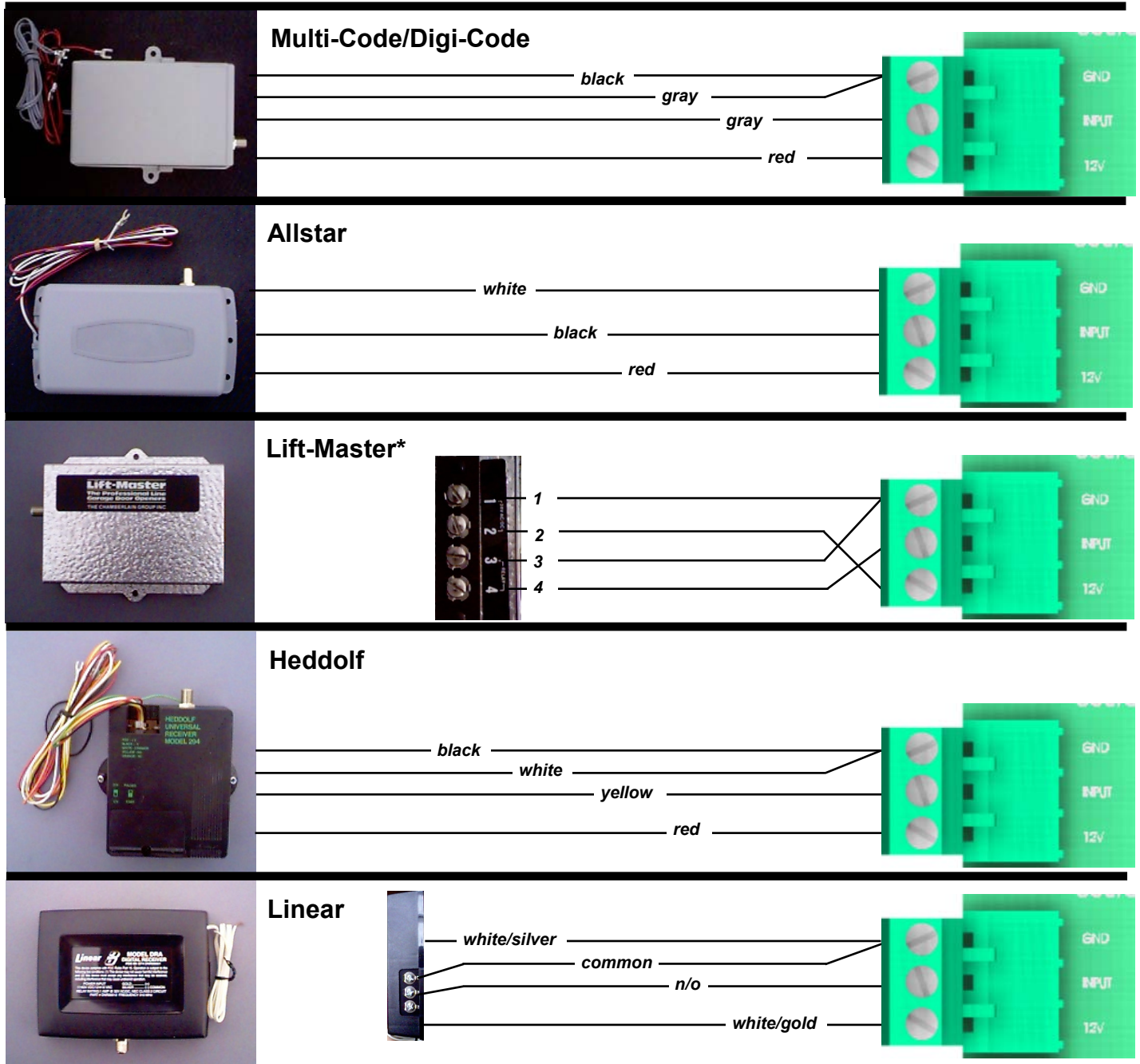

* Lift-Master will require that the 12/24 jumper be set to 12 and the C/M (constant/momentary) jumper be set to C

APOLLO *Gate Operators, Inc.*

LIMITED TWO-YEAR WARRANTY

Apollo Gate Operators are warranted against defects for a period of 24 months from the date of purchase, providing recommended installation procedures are followed. This warranty is in lieu of all other warranties expressed or implied (some states do not allow limitations on how long an implied warranty lasts, so this limitation may not apply to you) and shall be considered void if damage was due to improper installation or use, connection to improper power source, or if damage was caused by fire, flood, or lightning. The manufacturer will not be responsible for any labor charges incurred in the removal or replacement of defective parts.

In case of failure due to defective material or workmanship during the warranty period, the defective part will be repaired or replaced at the manufacturer's option at no charge if returned freight prepaid. New or factory rebuilt replacements may be used. Replacement parts are warranted for the remaining portion of the original warranty period. The manufacturer will pay standard ground freight on the return of repaired or replaced items in warranty.